



715 Center Street
Grayslake, IL 60030
Office: (847) 752-2700
Fax: (847) 752-2415
info@livorsi.com
www.livorsi.com

DUETSCH CONNECTOR HARNESS INSTRUCTION

for use on Mega & Race Series Electric gauges & Tachometers



Part # DCH
Four pin connector & wire harness

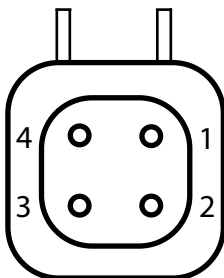

The wires from this harness are color coded and numbered for the following connections:

- Pin # 1 = BLUE, 12v+ illumination
- Pin # 2 = VIOLET, 12v+ ignition power
- Pin # 3 = BLACK, engine or battery ground
- Pin # 4 = GREEN, signal from sender



715 Center Street Grayslake IL 60030
 P: 847-752-2700 F: 847-752-2415
 E: info@livorsi.com

GAS TACHOMETER

Model # 's

DCS6000, DCS8000, DCS10000, DCS12000
 & DCL6000, DCL8000, DCL10000

INSTALLATION INSTRUCTIONS

Mounting:

1. Connect wires to tachometer per instructions
2. Secure tachometer using the bracket, nuts and lock washers provided. Use 4-6 lbs. in torque. More or excessive force will damage gauge and void warranty.

Wiring:

1. Connect the green wire (pin# 4 –signal) to the coil negative (-) on standard ignitions or to the tach terminal on electronic ignitions.
2. Connect the black wire (pin# 3- ground) to a good engine ground.
3. Connect the violet wire (pin# 2- 12V +) through the ignition switch or an ON/OFF switch to the positive (+) terminal of a 12V battery. *Note: In order to protect electrical wiring, fuse this connection.*
4. Connect the blue wire (pin# 1- illumination) to 12V lighting source.

Note: The pointer on your tachometer may not always rest at zero when the 12V power is off. This is normal. When the engine is started, the pointer will register the correct RPM.

DC Tachometer Cylinder Configuration					
Ignition	1	2	3	4	5
4 cyl	■	■	■	■	■
6 cyl	■	■	■	■	■
8 cyl	■	■	■	■	■
10 cyl	■	■	■	■	■
12 pole outboard	■	■	■	■	■

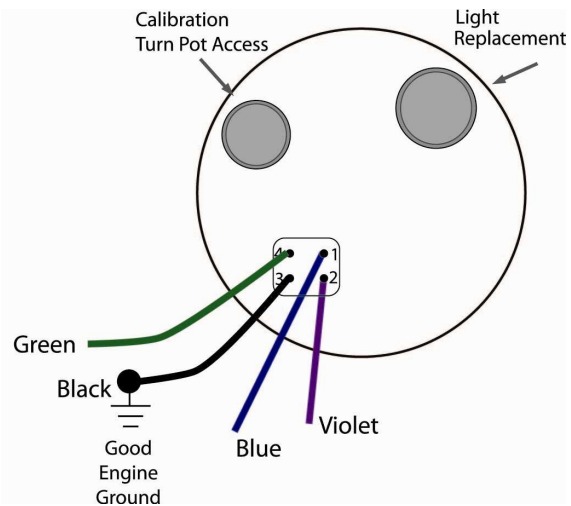

Part # DCH

Pin # 1 = BLUE, 12v+ illumination
 Pin # 2 = VIOLET, 12v+ ignition power
 Pin # 3 = BLACK, engine or battery ground
 Pin # 4 = GREEN, signal from sender

Mechanical Gauges Applying Torque to Fittings

Part Numbers beginning with: DCM or DCMS

1. Do not over torque the fitting or mounting screws, this will void the warranty.
2. Use multiple wrenches to counter torque fittings so as not to bend or damage the case. Bending/damaging the case makes the gauge inaccurate.

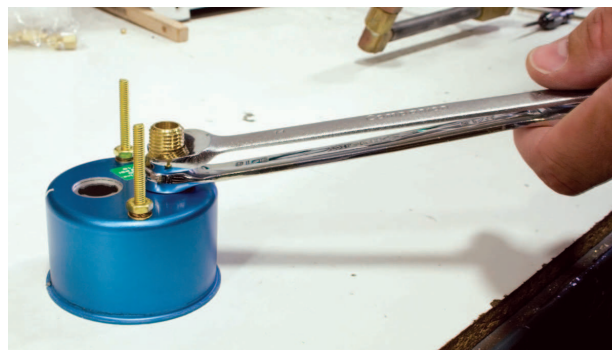

Mega and Race Series, Industrial Series GPS Installation

INSTALLATION

1. If you are using the supplied antenna, find a mounting location that will maintain an unobstructed view of the satellites. The antenna should be kept as close as possible to parallel with the horizon.
2. Hidden installation of the antenna is possible and can be determined by temporarily mounting the antenna in the desired location and checking the signal. Due to the differences in dash or deck thickness and materials, results are difficult to predict. The signals will not pass through metal, but may pass through glass and plexi windshields. Additionally, try to keep the antenna away from any aluminum or stainless frames.
3. Once a location is chosen, drill a 3/8" (9.5 mm) opening in the mounting panel.
4. Slide the antenna cable in to the opening and secure the antenna with silicone or double-sided tape (included).
5. If you are using an alternative antenna, make certain that its wiring is compatible with the gauge and proceed to step 6.

Refer to the drawing in this instruction for proper wiring.

BACK OF SPEEDOMETER

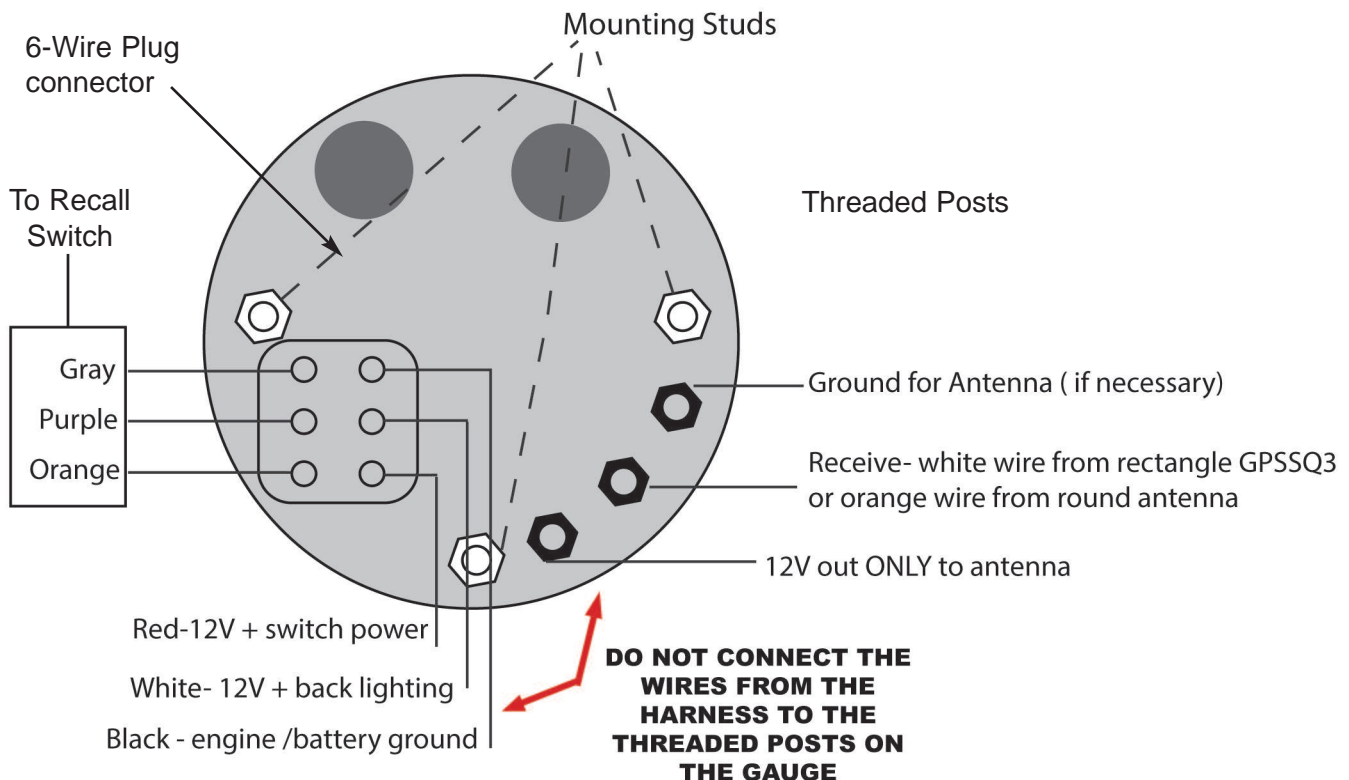

6. THE 6-WIRE PLUG WIRING TERMINATION

Separate the Purple, Orange and Gray wires for the recall switch away from this plug, towards the location where the recall switch will be installed.

7. The remaining three wires connect as follows:

RED - Switched 12v+ power

WHITE - Switched 12v+ power, optional switch for lighting in line
(can be connected to same point as RED if CONSTANT lighting is desired)

BLACK - Clean engine or battery GROUND

DO NOT, UNDER ANY CIRCUMSTANCES, CONNECT THE WIRES FROM THE 6-WIRE PLUG TO THE THREADED POSTS FOR THE ANTENNA CONNECTIONS. WARRANTY WILL BE VOID!!!!

8. THREE THREADED POSTS

There are three threaded posts on the rear of the gauge, labeled with the connections for the antenna. These are designed for OUTPUT of 12v POWER and GROUND connection for the antenna - NOT INPUT.

The INPUT is the center RECEIVE terminal, and will connect to the WHITE wire from the GPS antenna we sell. DO NOT CONNECT 12v+ and GROUND from the electrical system to these terminals - they are OUTPUT not input. Damage may occur and warranty will be void.

9. Find a suitable location for the recall switch, drill a 1/2" (12.5 mm) opening in the panel.

10. Center the opening in the panel with the opening on the cover plate, and mark the centers for the screws that will secure the cover plate to the panel. Secure the cover plate.

11. RECALL SWITCH CONNECTIONS:

Purple wire to the center terminal

Orange wire to the outside terminal on the same side as the "Recall" mark on the switch plate

Gray wire to the remaining terminal

WARNING:

Make certain that the purple wire is always connected to the center terminal.

SHORT- CIRCUITING OF THE ORANGE AND GRAY WIRES MAY LEAD TO CIRCUIT FAILURE AND WILL VOID THE WARRANTY!

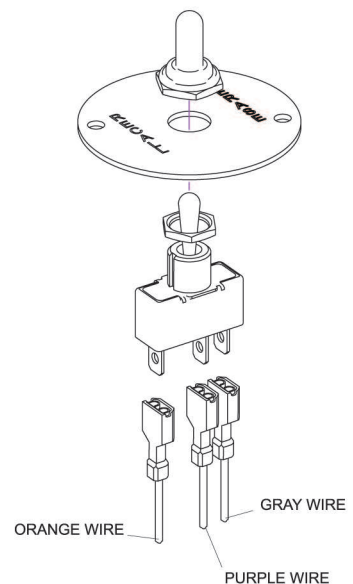

12. Fit the switch in to the opening, screw on the protective boot, and secure the switch with the nut from the other side of the panel.

13. Gauge Cutout

Cut out a 4 5/8" (117 mm) opening in the dash board for a GPSL series gauge
Or a 3 3/8" (86 mm) opening for a GPSS series gauge.

14. If possible, slide the wiring harness, through the opening and make all the electrical connections prior to fitting the gauge in to the panel. Otherwise mount the gauge first, and then make appropriate connections.

15. Fit the gauge in to the opening and rotate it to the desired position.

16. Slide the clamp over the mounting studs, and secure the clamp with provided keps nuts.
Torque the nuts to 4-6 in-lbs

WARNING:

Improper wiring may damage the gauge and/or the antenna. Incorrect connections will void the warranty!

OPERATION

When the gauge is powered up and the antenna is properly connected, it will go through a self-diagnostic mode. During this period, the pointer will move to about the 3 o'clock position for approximately three seconds. It will then move to the 12 o'clock position for an additional three seconds, and then return to 6 o'clock. This completes the diagnostic mode.

Next, the gauge will start finding the GPS signal. This process may last several minutes. Upon acquiring the signal, the pointer will move to "zero" or any other value that corresponds to current speed.

RECALL FUNCTION

The gauge is equipped with non-volatile memory that stores the highest attained speed. To display this speed simply toggle the switch in to the "Recall" position.

NOTE: The highest speed value will remain in memory even if there is no power to the gauge. To clear the memory, toggle the switch to the "Erase" position.

TROUBLE SHOOTING

Symptom: The gauge appears to be non-functioning, no backlighting is present.

Possible Cause: There is no power or suitable ground to the gauge.

Remedy: Verify connections to the gauge.

Symptom: No pointer movement during start up, backlight is present.

Possible Cause: Backlighting wire (white) has 12 volts, but the red wire does not.

Remedy: Verify connections to the gauge. If correct, verify the line voltage going to the RED wire (10-18 V DC) and the correct polarity in the system.

Symptom: Pointer remains in the same position indefinitely after power-up.

Possible Causes: Bad or no connection to the antenna, bad antenna, no clear reception to any satellites in range.

Remedy: Verify antenna connections. If correct, attempt to move vessel to a different location. If relocation does not resolve the issue, relocate antenna. If no change, replace the antenna.

Symptom: Pointer remains indefinitely in particular position after properly functioning.

Possible Causes: Lost antenna connection, damaged antenna, or lost satellite signal.

Remedy: Verify antenna connections. If correct, and relocation of the vessel does nothing, replace antenna.

For other concerns, contact tech support at 847-752-2700



715 Center Street Grayslake IL 60030
P: 847-752-2700 F: 847-752-2415
E: info@livorsi.com W: www.livorsi.com

Proper Installation for Mega & Race Plug-In Connectors



STEP 1: Insert the plug

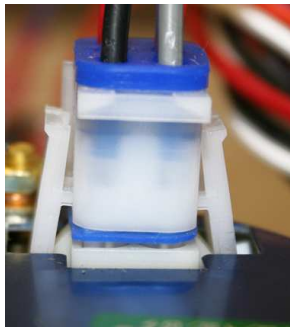

STEP 2: Push the plug in , you will hear a click.

Note the two locking tabs on the either side of the plug are resting at angles.



Not Connected



STEP 3: Push to one side of the plug, so that the locking tab clicks into a vertical position as shown here.



Not Connected

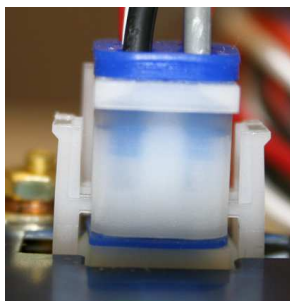

STEP 4: Push toward the other side so that the remaining locking tab clicks into a vertical position.

Both locking tabs should be in a vertical position.

The plug is now properly secured.



Proper Connection