

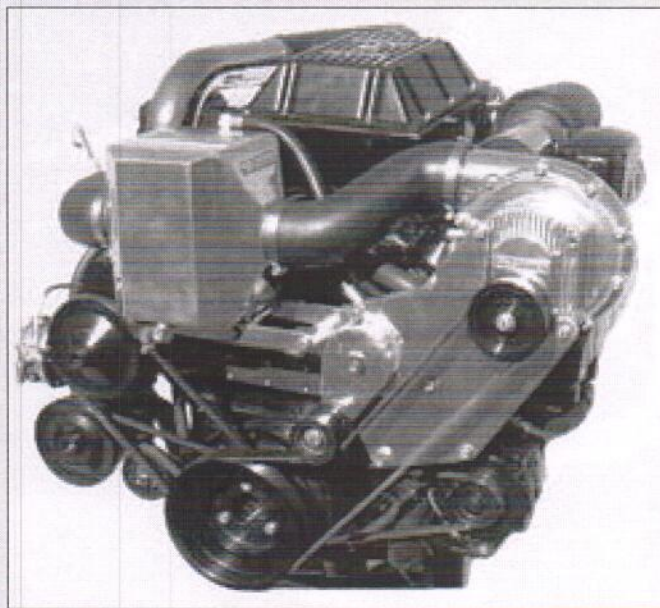
# OWNER'S MANUAL

MERCUISER CARBURETED MAGNUM/7.4

M-1/M-1SC INTERCOOLED SYSTEM

**PROCHARGER**<sup>®</sup>  
*Marine*

*Centrifugal Supercharger Systems*



*The Intercooled Supercharging Experts!*<sup>®</sup>



ACCESSIBLE TECHNOLOGIES, INC.  
© 2006 ATI, ALL RIGHTS RESERVED  
1MA281; 1MA222





## INSTALLATION OVERVIEW

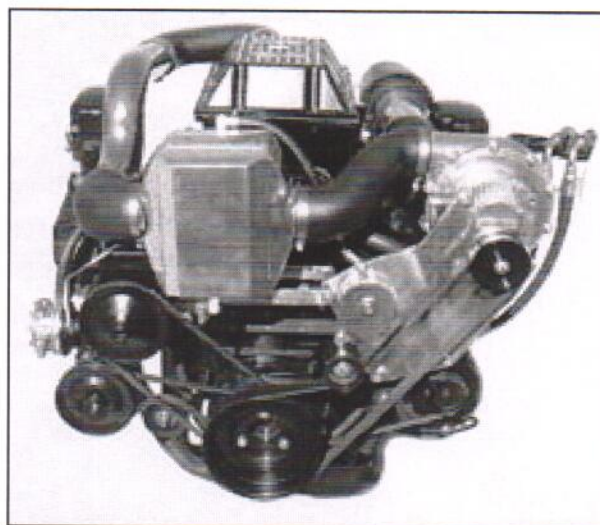
Congratulations on the purchase of your ProCharger® centrifugal supercharger system, and welcome to the world of centrifugal supercharging. You are now the owner of the most powerful and reliable supercharger system available, and the latest technology in supercharging!

This Owner's Manual contains the following sections:

- **INTRODUCTION**
- **INSTALLATION INSTRUCTIONS**
- **OPERATION AND MAINTENANCE**
- **WARRANTY**



If you are performing the installation of this system and this is your first ProCharger installation, you will likely benefit from reading the entire installation instructions prior to proceeding, and then reviewing each section as you go. If you are familiar with supercharging, remember that centrifugal supercharging is different from roots supercharging, and the same rules do not apply, primarily due to the unparalleled efficiency of the ProCharger, and the vastly cooler intake temperatures that result, especially when intercooled.

- A. OIL DRAIN SETUP**
- B. PREPARATION**
- C. OIL FEED SETUP**
- D. ENGINE ACCESSORY AND PROCHARGER INSTALLATION**
- E. CARBURETOR ENCLOSURE INSTALLATION AND BOOST-REFERENCED FUEL DELIVERY**
- F. AIR INLET ( AND OPTIONAL INTERCOOLER TUBING ) INSTALLATION**
- G. WATER LINE INSTALLATION**
- H. FUEL SYSTEM UPGRADES**
- I. INSTALLATION REVIEW AND SAFETY CHECK**
- J. GENERAL TUNING AND THEORY**
- K. OPERATION AND MAINTENANCE/SPECIAL NOTES FOR SC APPLICATIONS**



## IMPORTANT CONCEPTS FOR RELIABLE OPERATION!

With blow-through carburetion used in ProCharger Marine systems, **it is extremely important that your fuel delivery be boost-referenced.** This simply means that a boost line is run to your fuel system so that fuel pressure is increased by 1 psi for every 1 psi of boost pressure. For example, if your fuel pressure is 7 psi at idle and you run 9 psi of boost pressure without boost referencing, you would have 2 psi of net pressure (9 psi - 7 psi) forcing fuel back into your fuel tank! By running a boost reference line, when boost pressure reaches 9 psi your fuel pressure will now be at 16 psi to ensure proper fuel delivery. In this example, net pressure will still be 7 psi (16 psi - 9 psi), so you have maintained the same net fuel pressure you had at idle. Please refer to section E of the enclosed installation instructions for more information. **Failure to properly boost-reference your fuel delivery can result in severe engine damage!** You should also ensure that you have proper jetting in your carburetor. **Never run a ProCharged motor with stock jets!** Please refer to the tuning section at the end of this manual regarding jetting.

Torque Specification Chart	 <b>Grade 5</b> Torque (lb. ft.)			 <b>Grade 8</b> Torque (lb.ft.)		
	Thread Size					
1/4-20	11	8	7	16	12	10
1/4-26	13	10	8	18	14	11
5/16-18	23	17	14	33	25	20
5/16-24	26	19	15	36	27	22
3/8-16	41	31	25	58	44	35
3/8-24	47	35	28	66	49	39
7/16-14	66	49	40	93	70	56
7/16-20	74	55	44	104	78	62
1/2-13	101	75	60	142	106	85
1/2-20	113	85	68	160	120	96

## INSTALLATION OVERVIEW

For best results we recommend that you review the installation instructions beforehand, and follow the installation instructions closely and in sequence. A detailed packing list is provided (inside box) to help you identify the components of your ProCharger Marine system. The following tools will be required to install your ProCharger Marine supercharger system:

### REQUIRED TOOLS & SUPPLIES

- 3/8" SOCKET SET (STANDARD & METRIC)
- 1/2" SOCKET SET (STANDARD & METRIC)
- SCREWDRIVER SET
- OPEN END WRENCH SET (STANDARD & METRIC)
- RAZOR BLADE OR CARPET KNIFE
- ADJUSTABLE WRENCH
- NUT DRIVER SET
- 8 SPARK PLUGS\*\*
- SPARK PLUG SOCKET\*\*
- OIL FILTER<sup>1</sup>
- 9 QUARTS ENGINE OIL (STRAIGHT 40W AS RECOMMENDED BY **MERCUISER**)<sup>1</sup>
- HEAVY GREASE\*<sup>1</sup>
- SILICONE SEALER\*<sup>1</sup>
- LARGE HAMMER\*<sup>1</sup>
- 3/8" NPT TAP\*<sup>1</sup>
- 9/16" TAPERED PUNCH\*<sup>1</sup>
- CENTER PUNCH\*<sup>1</sup>
- PLIER SET
- WIRE CUTTERS
- OIL FILTER WRENCH<sup>1</sup>

You should also have the following gauges available to properly check the finished installation and monitor your vessel's performance (especially for high performance applications):

- boost/vacuum gauge (plumbed to intake manifold)
- fuel pressure gauge (0-100 psi) (plumbed to ATI fuel pressure regulator)

Both gauges should be of a type that can be read from the cockpit while performing a W.O.T. performance test. Cockpit-mounted gauges are preferable, although use of a shop fuel pressure gauge (which has a hose long enough to be read during testing) is an option.

The motor on which the ProCharger is installed should have stock compression. If your engine has been modified in any way, please check with ATI or your dealer before proceeding. This supercharger system is intended for use on strong, well maintained engines. Installation on a worn or troublesome engine should be reconsidered. **Accessible Technologies is not responsible for damage to an engine.**



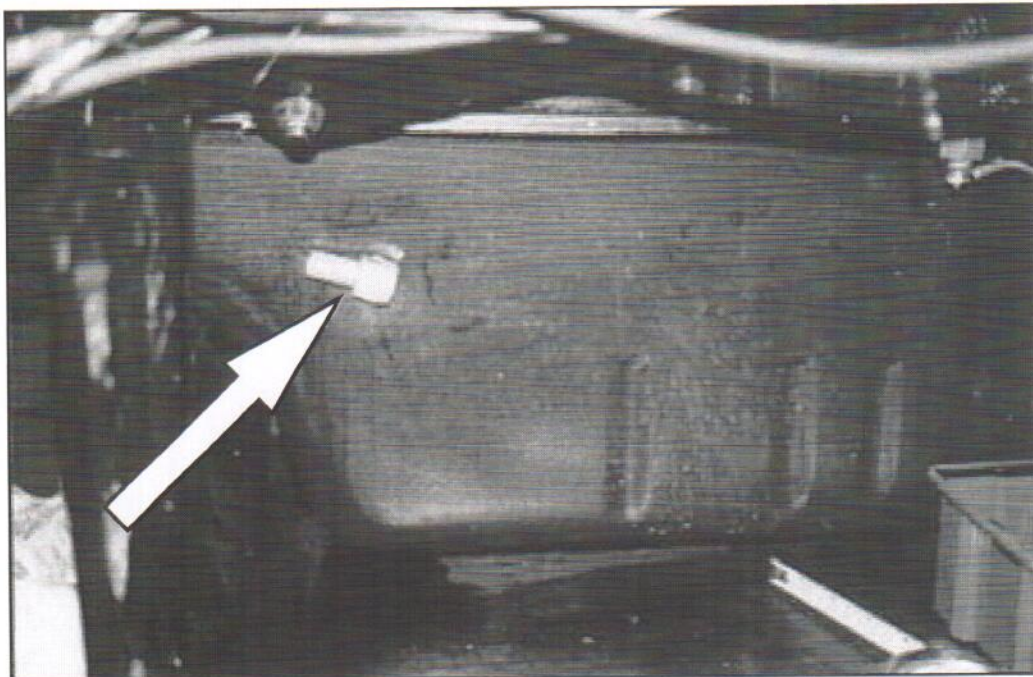
**Warning: Motor and propeller should be configured so that maximum speed does not exceed boat manufacturer's recommendations for your hull.**

Note: There are minor variations in Mercruiser motors across model years (such as water hose routing for coolers) which may not *specifically* be addressed in these installation instructions. Please contact an ATI service technician should you have any questions.

\* if oil pan does not already have oil return fitting

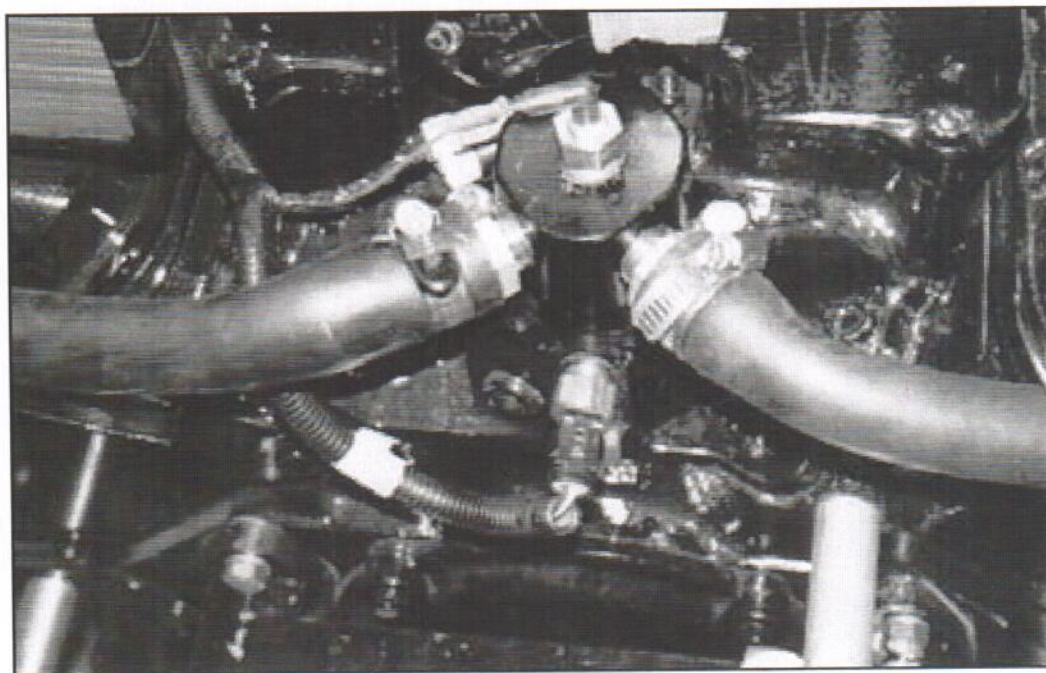
\*\*if current plugs have more than 100 hours, or are more than 1 yr old

<sup>1</sup>Not required for Self Contained (SC) Applications



**FIGURE A1**

*OIL DRAIN FITTING LOCATION AND ORIENTATION*  
FITTING SHOULD POINT FORWARD, ANGLED SLIGHTLY UPWARD



**FIGURE B1**

**THERMOSTAT HOUSING INSTALLATION**

# INSTALLATION INSTRUCTIONS

## **A. OIL DRAIN SETUP (OMIT ON SC KITS)**

*Completion of this section will establish a fitting for the oil return line, which drains oil from the ProCharger into the engine oil pan*

### **DESCRIPTION AND OPERATION**

The main components consist of the oil drain fitting and oil return line. The oil return line is routed from the ProCharger to the oil pan. The drain fitting is installed in the oil pan via either an existing threaded hole or one that must be created. This is a gravity feed system, therefore, this oil return line must be kink free and downhill the entire length, and should drain into the pan above the oil level line.

#### **Pre 1996 motors**

1. Remove the 3/8" NPT plug located in the port side of the engine oil pan. (see figure B1)
2. Using silicon sealer or other hydraulic sealer, install supplied 3/8" NPT- 1/2 " barb 90° elbow such that it faces forward and slightly up.

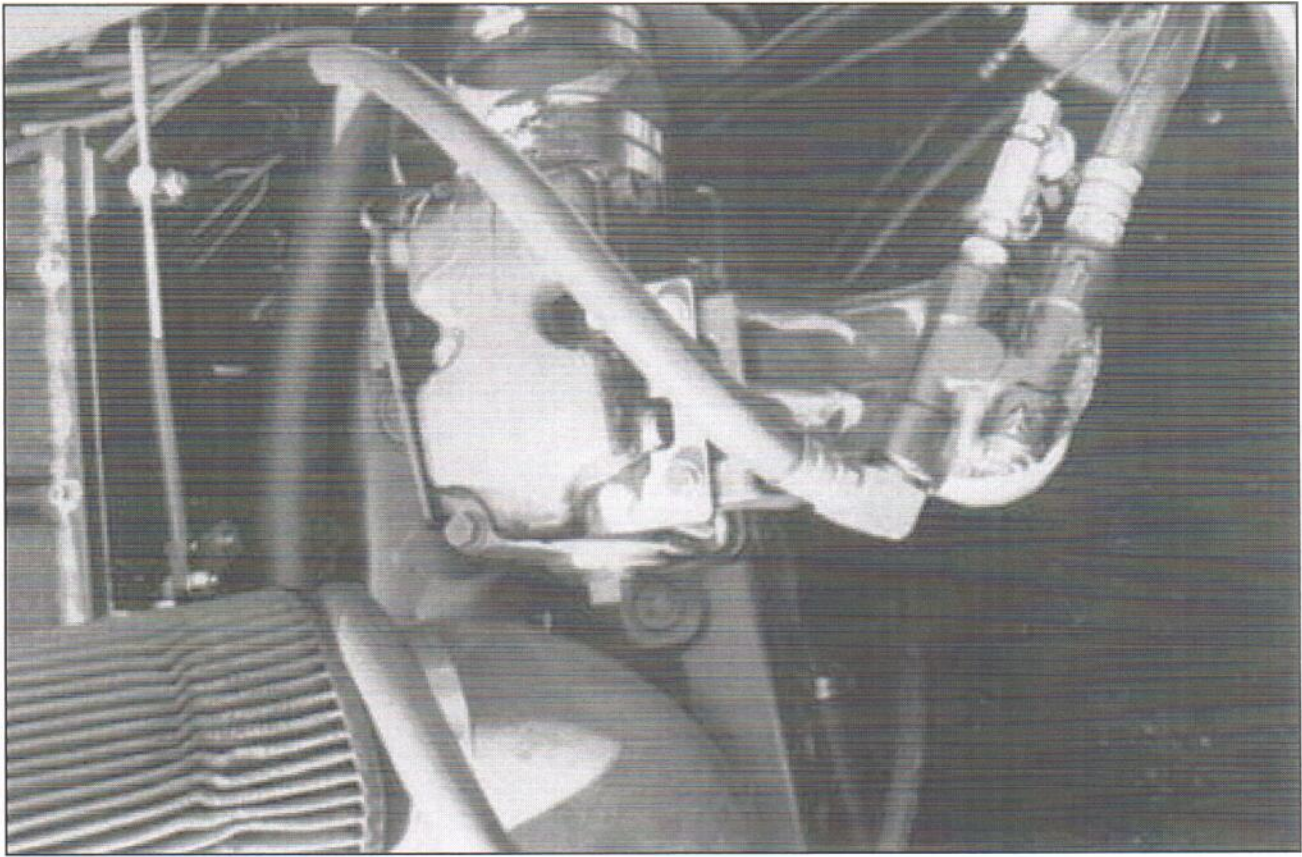
#### **1996 and after motors**

1. Punch (Don't drill) a small pilot hole 1" behind the fourth bolt hole from the front on the port side of the pan and 3" down from the pan flange. Stepping up punch sizes sequentially, enlarge pilot hole to approximately 9/16". Offshore engine mounts - punch and tap the drain hole 1/2" in front of second oil pan bolt and 2 1/2" down from the flange.
2. Coat a 3/8" NPT (National Pipe Thread) tap with a layer of thick grease. (FYI: 3/8" NPT refers to the pipe's inner diameter. Tap hole in oil pan. Clean any foreign matter from inside of pan.
3. Using silicone sealer, install the supplied oil return fitting into the pan.
4. Temporarily attach the oil return line to the fitting. Perform an oil and filter change at this point. After initially draining the oil, pour approximately 1/2 quart of oil down the drain line to flush all chips from side of pan, then continue with oil change normally. Remove oil return line from fitting until done later.

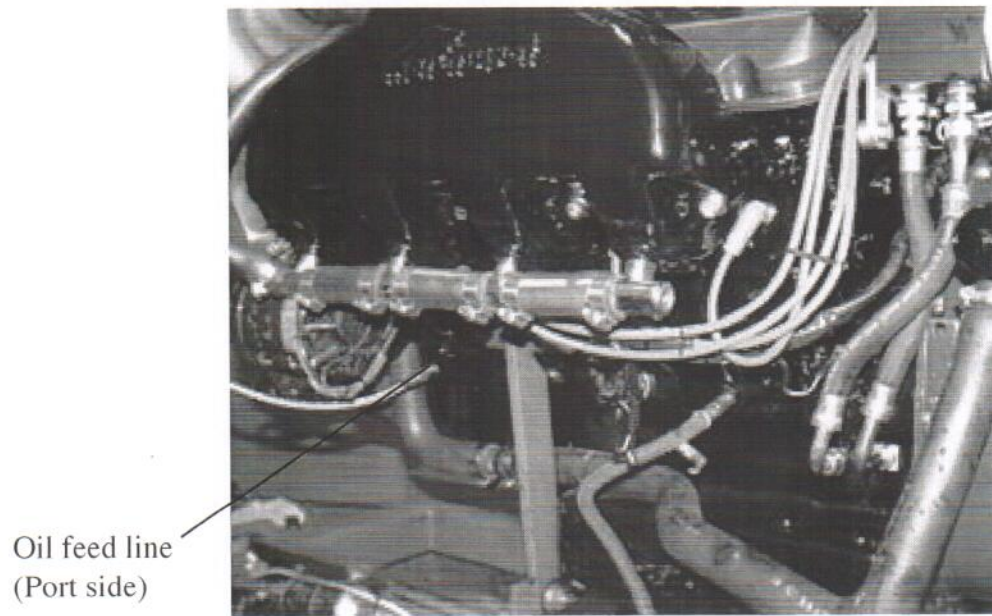
## **B. PREPARATION**

*Completion of this section will configure motor for installation of the ProCharger system.*

1. Remove all engine accessories from front of motor except the sea water pump and harmonic balancer ( water pump, power steering pump, alternator, and crank pulley). Remove the stud which threads into the lowest of the holes in the front of the head and helps hold the seawater pump on.
2. Remove water lines running to the thermostat housing assembly. Remove the thermostat housing assembly from the top front of the intake manifold.
3. Install ATI supplied thermostat housing using new gasket (supplied). Do not install a thermostat!
4. Remove the brass fitting from the front (facing forward) of the intake manifold. Remove the 1/2" NPT plug from the top of the intake manifold adjacent to the thermostat inlet. Install this plug into the hole in front of intake manifold previously occupied by fitting. Install the supplied 1/2" MPT to 3/8" FPT bushing into the hole adjacent to the thermostat housing. Install overheat warning sending unit from factory thermostat housing into bushing. If the plug in the manifold is not present, remove the plug from the side of the thermostat housing. Install overheat warning sending unit from factory thermostat housing into the ATI thermostat housing. Use the plug removed from the oil filter housing in step 1 of section C to plug the hole in the front of the manifold.
5. Install second sending unit from stock Mercruiser thermostat housing into top of supplied thermostat



**FIGURE C1**  
**OIL FILTER BRACKET INSTALLATION**



**FIGURE C2**  
**OIL FEED LOCATION**



- housing.
6. Install supplied crossover tube between the two water pump ports using supplied gaskets, 3/8" washers, and 3/8" x 1" bolts. Crossover should be installed with fittings on top (see figure G2).
  7. If you have hoses running from your stock thermostat housing to the **top** of your exhaust in addition to the hoses running to the bottom, remove fittings from top front of exhaust manifolds. Install supplied 3/4" NPT plugs. If they are the non removable types, cap off and clamp.
  8. 1996 and newer motors will have a separate oil cooler running vertically on the front of the motor. This oil cooler will need to be moved back to the lower port side of the motor by the power steering cooler as on pre '96 motors. Remove the two oil fittings from the oil cooler body. Remove the cooler from the water hoses running up the front of the motor.
  9. Remove the water hoses from the back of the power steering cooler. Using the supplied short 1 1/4" rubber connector and two hose clamps, attach the discharge end of the oil cooler to the inlet end of the power steering cooler.
  10. Cut the hose from the seawater pump previously attached to the back of the power steering cooler just before the 180° bend. Using the supplied straight metal tube and two hose clamps, extend the hose so that it runs back and up to the inlet of the oil cooler. Clamp the hose to the oil cooler securely.
  11. Using the supplied straight metal connector, clamp the supplied 1 1/4" rubber extended 90° elbow between the discharge hose of the power steering cooler and the fitting on the crossover tube installed in step 5.
  12. Install ATI supplied crankshaft pulley assembly. **Note: If installing a 12 rib crank pulley, be sure the .125" shim is between the triple vee pulley & the 12 rib pulley.**

### **C. OIL FEED SETUP (OMIT ON SC KITS)**

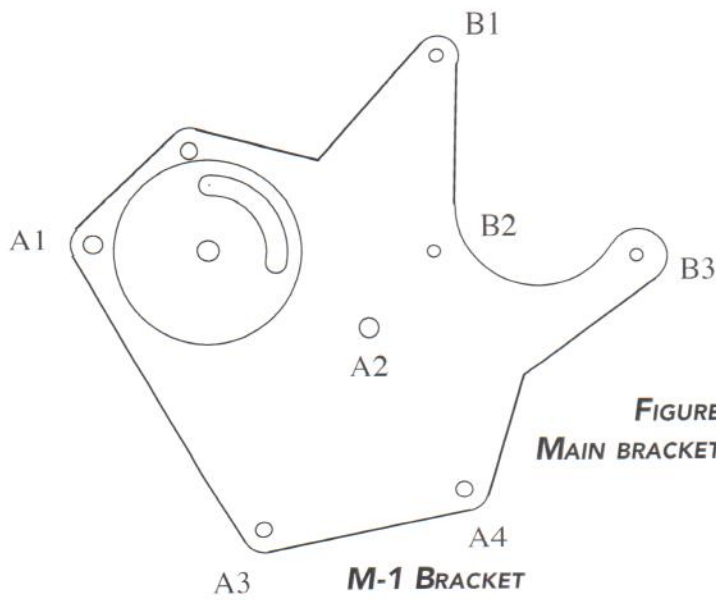
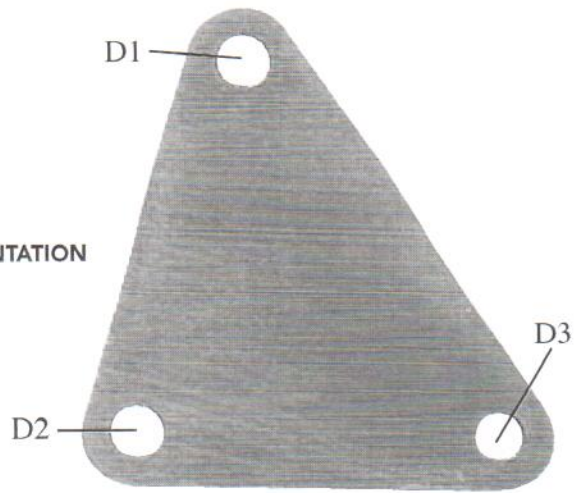
*Completion of this section will allow establishment of an oil feed line from the engine to the ProCharger for oil mist lubrication of bearings and gears.*

#### **DESCRIPTION AND OPERATION**

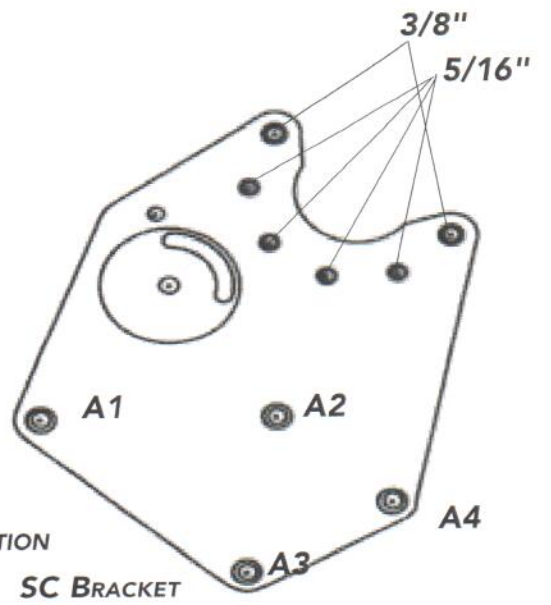
The main components consist of the oil feed fitting and oil feed line. The oil feed bushing is installed in the vacant oil galley port located near the front of the motor, on the port side, and provides an oil supply port for the feed line. The oil supply at this location is just downstream of the oil filter. The oil supply is used to supply filtered, high pressure oil to the ProCharger bearings and gears.

1. Remove the oil lines from the oil filter housing. Remove the oil filter housing from the exhaust manifold. Attach the supplied oil filter bracket to the port side outboard exhaust riser bolts. Attach the oil filter housing to the bracket with the tabs on the underside of the bracket. See Figure C1. Pull the oil lines out from beside the computer box. Reroute the lines back up to the relocated oil filter housing and securely reattach to the aft/back ports on the oil filter housing; it will be necessary to relocate the plugs in the housing. **Note:** twin engine applications may require purchase of optional transom-mount hardware, due to the lack of side clearance.
2. On the port side of the motor, locate the forwardmost plug (near the front of the motor) in the oil galley. Remove the plug and install the supplied 1/4" MPT - 4 fitting into the port. See Figure C2.
3. Connect the oil feed line to the bushing. **Do not use Teflon™ tape or sealant on the fitting**, as this could block the ProCharger oil inlet and damage the precision bearings inside the ProCharger, voiding your warranty.

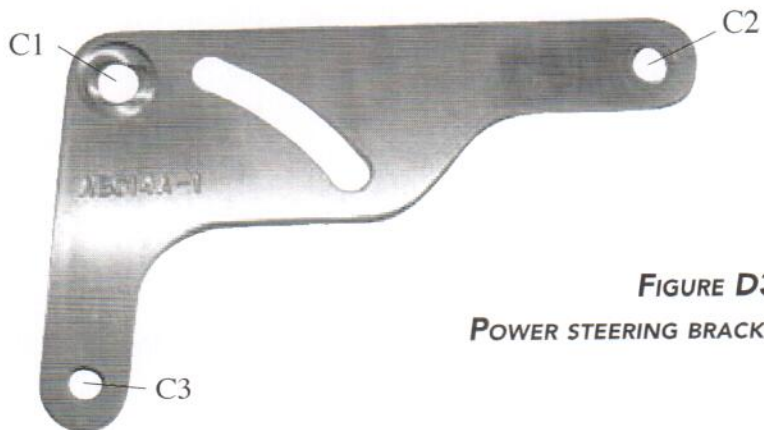
**FIGURE D1**  
**ALTERNATOR BRACKET ORIENTATION**



**FIGURE D2**  
**MAIN BRACKET ORIENTATION**



**SC BRACKET**



**FIGURE D3**  
**POWER STEERING BRACKET ORIENTATION**

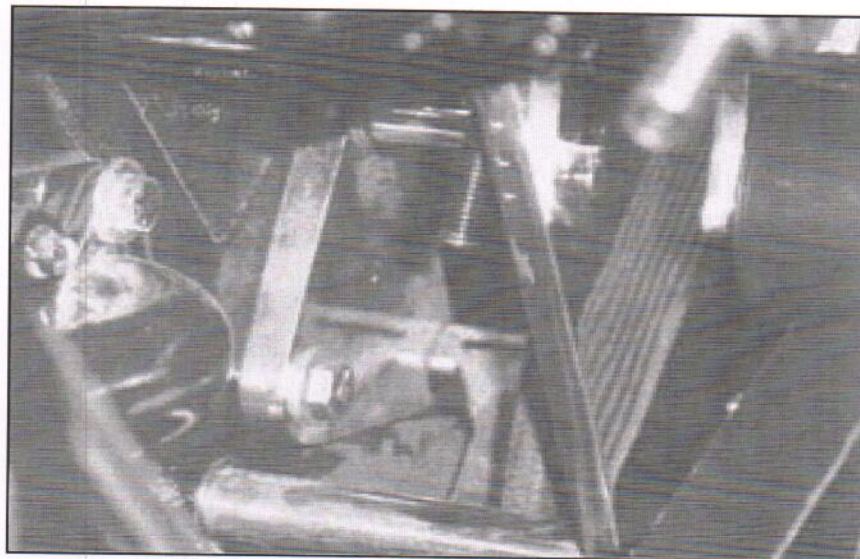
## **D. ENGINE ACCESSORIES AND ProCHARGER INSTALLATION**

*In this section you will install the ProCharger and connect all related oil lines and air hoses*

### **DESCRIPTION AND OPERATION**

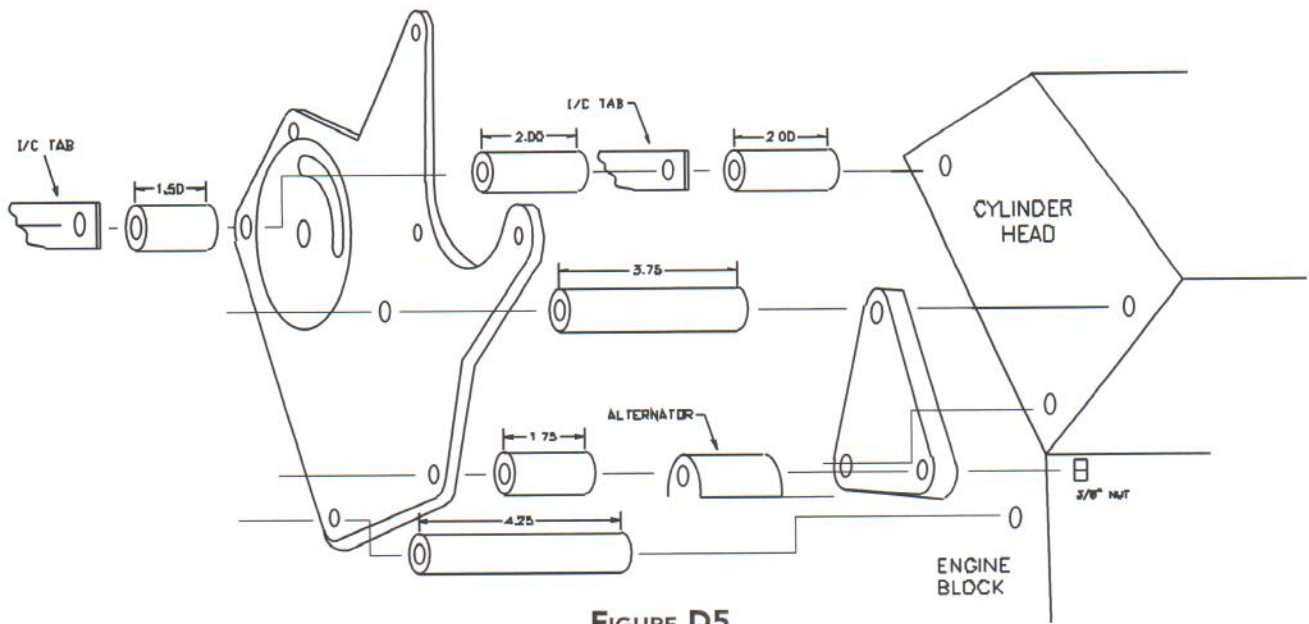
The main components of the ProCharger system are the ProCharger, ProCharger mounting bracket, alternator bracket, and power steering bracket. The ProCharger is a gear-driven centrifugal compressor, driven by an 8 or 12 rib serpentine belt. It uses a billet aluminum impeller, super precision bearings and carburized gears. The impeller speed is dictated by engine rpm, crank pulley-to-driven pulley ratio and the final internal gear ratio. As engine speed is increased both airflow and boost (resulting from engine back-pressure) are increased. The quoted boost levels of the kit can be exceeded if the factory-set redline is surpassed. The mounting brackets are flat billet aluminum types which utilize a series of spacers to properly position the ProCharger and alternator, and relocate the power steering pump.

1. Back on the port side, bolt the supplied triangular shaped Alternator bracket to the head using the lowermost head bolt hole and hole D2 from figure D1 with the 7/16 x 1" bolt. The bracket should be oriented so that hole D1 matches up with the upper head bolt hole and the 3/8" hole (D3) sits in the lower of the two positions as shown in figures 4 and 5.
2. Bolt the ProCharger main bracket to the motor using bracket holes A2 and A3. (from figure D2) Hole A3 uses the 4 1/4" spacer and a 3/8" x 5.5" (3/8" x 5" on SC system) bolt. Hole A2 uses the 3 3/4" spacer and a 7/16" x 5.5" (7/16" x 5" on SC system) bolt which goes through the bracket, the spacer, and then hole D1 on the alternator bracket.
3. Reattach the factory alternator lower support bracket in it's original position. Slide the alternator up so that the upper support hole is in front of hole D3 on the ATI alternator bracket and behind hole A4 on the main bracket. Slide the 1 3/4" spacer between the alternator and the main bracket. Run the remaining 3/8" x 5.5" (3/8" x 5" on SC system) bolt through the main bracket, spacer, alternator, and alternator bracket and thread the 3/8" nylon locking nut onto back side (see figure D4 & D5). Leave somewhat loose until you tighten alternator belt.

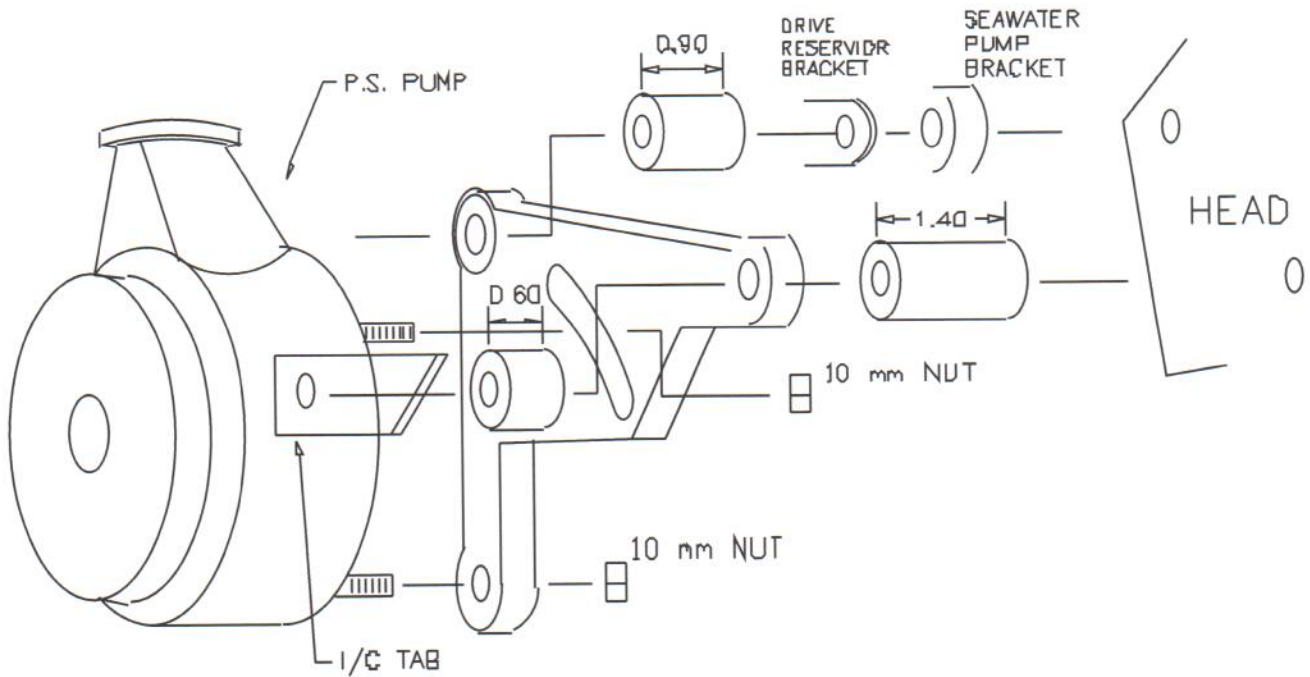


**FIGURE D4**

**THE ALTERNATOR SUPPORT BRACKET MOUNTED TO HEAD, WITH  
ALTERNATOR AND MAIN BRACKET SPACER ATTACHED**

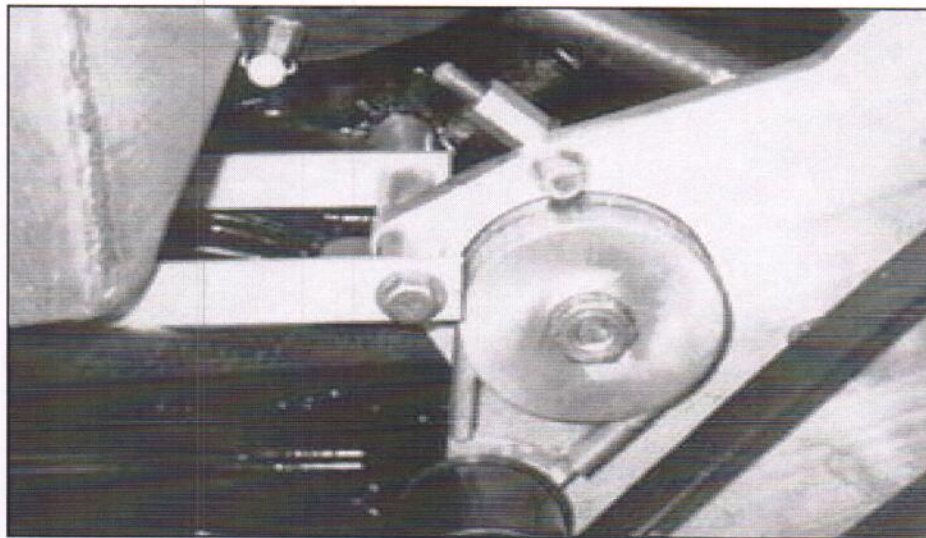


**FIGURE D5**  
**EXPLODED VIEW OF MAIN BRACKET AND SPACERS**

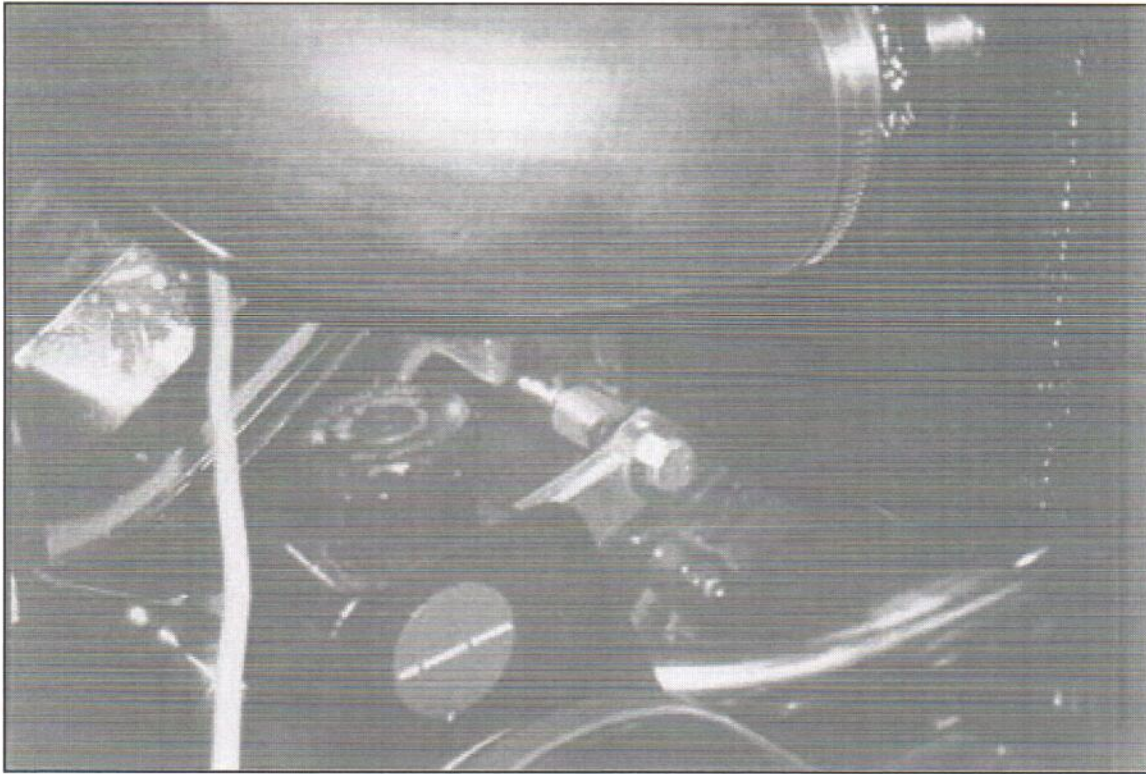


**FIGURE D6**  
**EXPLODED VIEW OF POWER STEERING BRACKET AND SPACERS**

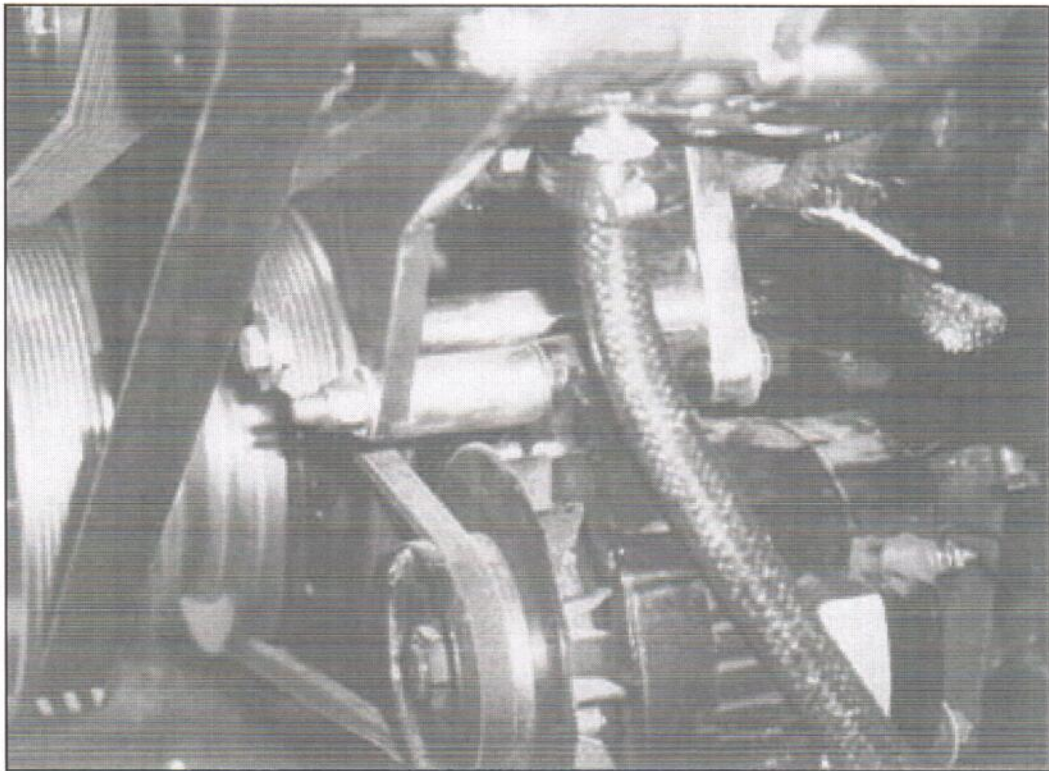
4. Attach the pistol shaped power steering bracket to the starboard side head oriented as shown in figure D3. The countersunk hole (C1) goes to the outboard-most hole in the seawater pump bracket where the stud was removed in step 1, with the .90" spacer going between the power steering bracket and the seawater pump bracket. Hole C2 should line up with the inboard-most head bolt hole.
5. If you will be mounting your intercooler remotely, follow 6R and 7R, otherwise proceed. Take the intercooler (I/C). The I/C tabs should be on the bottom of the I/C with the side with two tabs facing the port side of the motor. Attach the starboard side tab to the power steering bracket and the starboard side head in the following sequence: I/C tab in front, then .6" spacer, hole C2 in the power steering bracket, then 1.40" spacer against the head. Run the 7/16" x 3 1/4" bolt through all four, and thread into the innermost head bolt hole. Leave slightly loose so that you can rotate the I/C into place on the port side. (see figures D5 and D7)
- 5R. Use the other 1.4" power steering spacer to bolt C2 to the head.
6. The starboard side I/C tabs will mount to the innermost bolt hole on the starboard side head in the following sequence: front I/C tab in front, then 1.5" (1.8" on SC system) spacer, main bracket hole A1, then 2" spacer, then rear I/C tab, and finally the other 2" spacer. Run the 7/16" x 7" bolt through, and thread into the head bolt hole. (see figures D6 and D8)
- 6R. Using the other 4.25" spacer, bolt hole A1 to the head.
7. Tighten all bolts installed up to this point securely.
8. Remove the factory angled support bracket from the front of the power steering pump. Reverse the ends of the bracket so that the shorter end is now at the pump. Reattach to the pump.
9. Two bolts hold the seawater pump idler pulley to the seawater pump bracket. Remove the upper of the two bolts.
10. Place two supplied shims over the lower power steering stud. Install the power steering pump with the lower stud through hole C3 in the power steering bracket. The upper stud goes into the arched groove. The lower support bracket bolts to the seawater pump bracket at the point where the bolt was removed in the previous step. Thread the original nuts down onto the studs.



**FIGURE D7**  
**PORT SIDE INTERCOOLER TABS MOUNTED TO MAIN BRACKET AND HEAD.**



**FIGURE D8**  
**STARBOARD SIDE INTERCOOLER TABS MOUNTED  
TO THE POWER STEERING BRACKET AND HEAD.**



**FIGURE D9**  
**THE COMBINATION OF BRACKETS, SPACER, AND ALTERNATOR ALL BOLTED TOGETHER.**  
**ALSO NOTE THAT, THE OIL RETURN LINE SHOULD DRAIN CONTINUOUSLY DOWNHILL  
FROM THE ProCharger, WITH NO KINKS IN THE LINE.**

11. The power steering lines will need to be rerouted to reach the pump. The high pressure fitting should be brought up from underneath the pump (instead of from above as before) and threaded tightly. The return line should be replaced by the supplied section of 3/8" line, cut to proper length, and clamped onto it's fitting. The power steering pump pulley may need to be pushed back on it's shaft as much as 1/8" to properly align with the crank pulley. Install the Gates #7390 belt on the alternator, the stock belt on the seawater pump, and the Gates #7417 on the power steering pump.
- 12a. M1: Using the supplied 5/16" x 1 1/4" bolts, and holes B1, B2, and B3 on the main bracket, attach the ProCharger to the main bracket. Connect the oil feed line to the fitting on the side of the ProCharger. Attach the oil drain line to the fitting on the pan. Clamp down. Route the oil drain line up to the ProCharger oil return fitting on the bottom of the ProCharger. Cut the line to the proper length and clamp to the oil drain fitting.

**This is a gravity feed system; the oil return line must be kink free and downhill the entire length, and should drain into the pan above the oil level line.**

- 12b. SC: Using the supplied (4) 5/16" and (2) 3/8" socket head cap screws, attach the ProCharger to the main bracket.
13. Place the serpentine belt around the crankshaft pulley and ProCharger driven pulley. The spring loaded idler should be above the belt pushing down. Tighten the large brass nut down to tighten the idler down onto the belt. Tension to approximately the second mark on the side of the tensioner. Tighten the 3/8" brass lock nut on top of the large brass nut, the 1/2" main bolt holding the tensioner to the main bracket, the 3/8" bolt going into the back of the tensioner, and the swing bolt the brass nut pushes against.

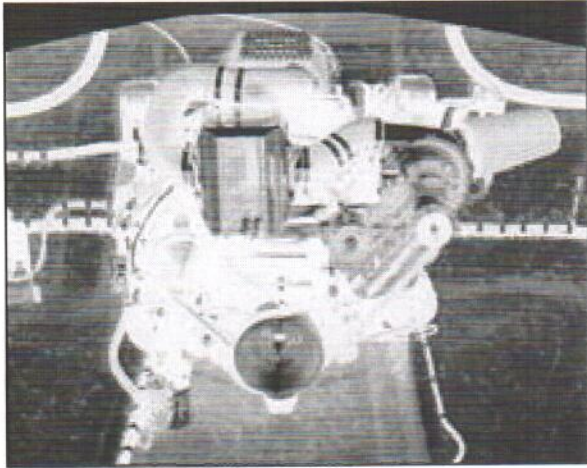
## **E. CARBURETOR ENCLOSURE INSTALLATION AND BOOST-REFERENCED FUEL DELIVERY**

*In this section you will install the supplied carburetor enclosure onto the intake manifold, install the carburetor inside the enclosure, and then attach fuel lines and throttle linkage. **Fuel delivery to the carburetor must be boost-referenced as instructed for adequate fuel delivery.***

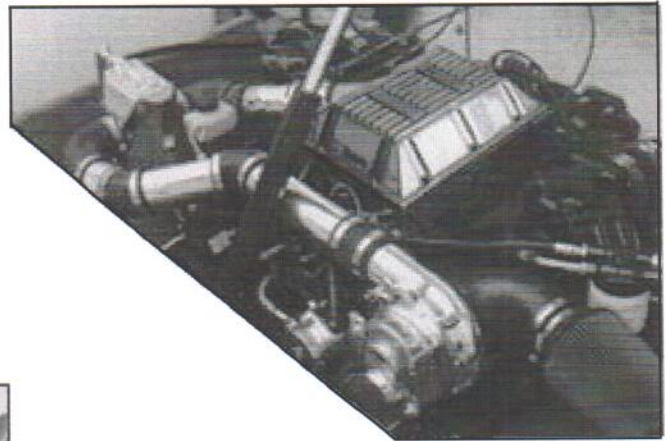
### **DESCRIPTION AND OPERATION**

The carburetor enclosure consists primarily of a 2-piece metal enclosure with integrated fuel lines and throttle linkage to interface with a Holley carburetor with mechanical secondaries. The enclosure is mounted to the intake manifold in place of the carburetor, with the carburetor being moved inside the enclosure. Fuel delivery to the carburetor must be boost-referenced so that adequate fuel pressure is maintained. This simply means that a boost line (from the carb box) is run to your fuel pump or regulator so that fuel pressure is increase by 1 psi for every 1 psi of boost pressure. For example, if your fuel pressure is 7 psi at idle and you run 9 psi of boost pressure without boost referencing, you would have 2 psi of net pressure (9 psi - 7 psi) forcing fuel back into your fuel tank! By running a boost reference line, when boost pressure reaches 9 psi your fuel pressure will now be at 16 psi to ensure proper fuel delivery. In this example, net pressure will still be 7 psi (16 psi - 9 psi), so you have maintained the same net fuel pressure you had at idle. **Failure to boost-reference your fuel system for proper fuel delivery will result in inadequate fuel pressure and possibly severe engine damage!**

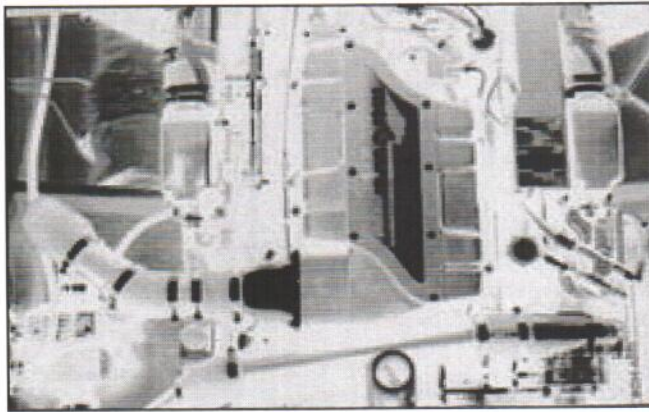




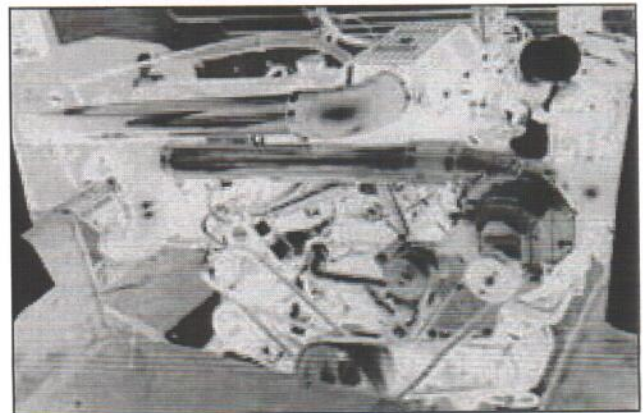
**FIGURE F1**  
**TYPICAL ENGINE MOUNT INTERCOOLER**



**FIGURE F2**  
**TYPICAL REMOTE MOUNT INTERCOOLER**



**FIGURE F3**  
**TYPICAL REMOTE MOUNT INTERCOOLER**



**FIGURE F4**  
**TYPICAL REMOTE MOUNT INTERCOOLER**



1. Place the supplied carburetor gasket onto the intake manifold. Place the carburetor box bottom onto the gasket with the fuel lines facing forward. Using 4 of the 1/4" socket head cap screws, bolt the box to the intake manifold. Place the thin Holley style carb gasket into the box on the carburetor mounting pad. Lower the carburetor into the box. Using the remaining cap screws, bolt the carb to the inside of the box.
2. Run the brass bushing through the carb throttle linkage from the inside and attach to the throttle linkage in the box. Connect the two fuel lines to the carburetor; shorter line to the back bowl. Connect the aluminum tube on the floor of the box to the fitting on the side of the metering block.
3. Remove the stud from the Mercathode bracket which the throttle cable attaches to. Screw the stud into the threaded hole in the back side of the box. Attach the rear of the throttle cable. Bend the end of the Mercathode bracket and attach the bracket to the 5/16" hole in the port side rear of the intake manifold. The Mercathode should now be located just over the back of the valve cover. Connect the front of the throttle cable to the throttle linkage in the box. Test the throttle and adjust as needed.
4. Install the flame arrestor/filter on the carburetor.
5. Place the green box gasket over the mounting flange of the box bottom. Place the top with the inlet facing forward onto the bottom and attach with supplied cap screws.
6. Connect the 1/4" aluminum tubing (for boost-reference) between the fitting on the fuel pump (or boost sensitive regulator for competition fuel systems) and the fitting on the back of the carb box with the supplied hose sections and clamps.



**Failure to securely connect this boost-reference line can result in severe engine damage!**

## **F. AIR INLET AND INTERCOOLER TUBING INSTALLATION**

*The intercooler will either be mounted on the engine using the power steering and main bracket spacers, or remotely. If you are using the engine mounted intercooler, it should already be installed. If you are mounting the intercooler remotely, you will need to do so now with this section as a guide.*

### **DESCRIPTION AND OPERATION**

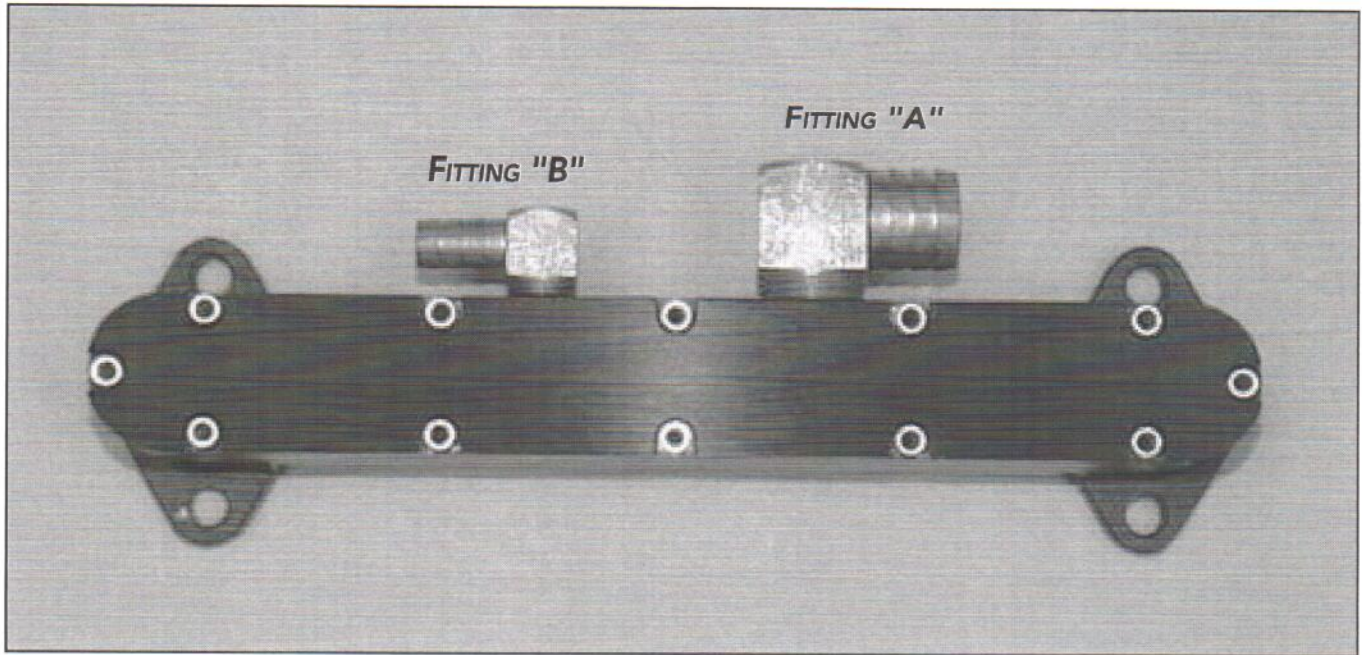
The intercooler system main components consist of the intercooler and tubing. The intercooler is a two core, plate style, air-to-water heat exchanger. The charge air (compressed and therefore heated) coming from the ProCharger enters the intercooler plenum, passes thru a series of passages and exits the opposite plenum. Water taken from the seawater pump is pumped through the crossflow passages in the intercooler, thereby cooling the charge air. The cooled charge air is then routed to the carburetor. The air inlet system uses a bellmouth which is connected to the inlet of the ProCharger.

### **Engine mounted intercoolers:**

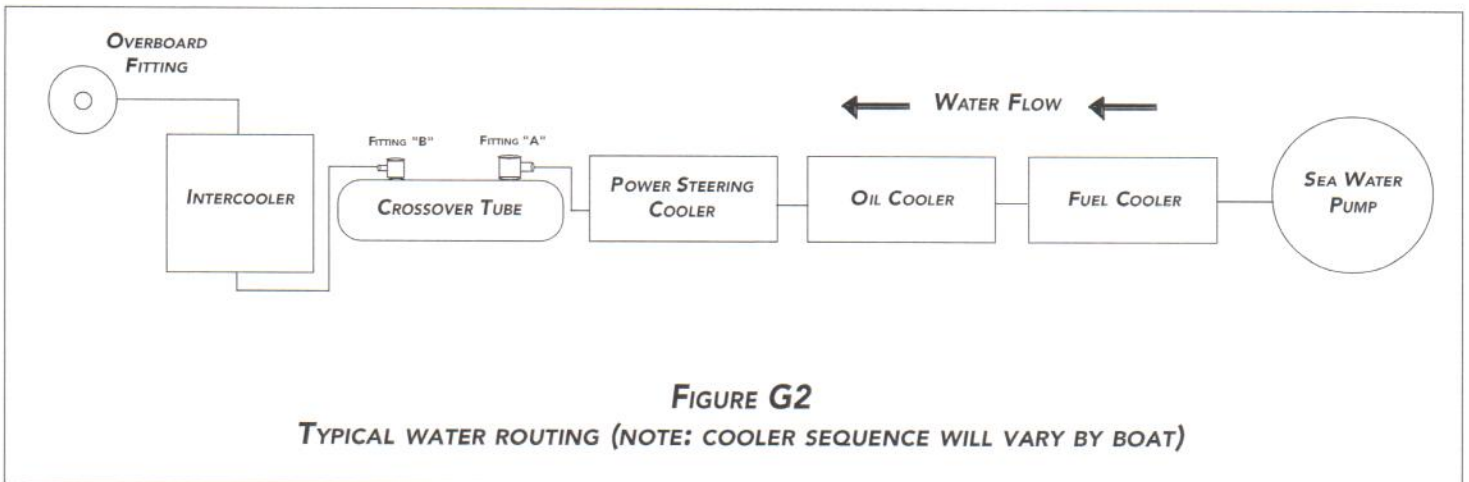
1. Place supplied molded S-hose over the outlet of the ProCharger and connect to the intercooler. Clamp both ends securely.
2. Connect the 3" 180° elbow to the outlet of the intercooler so that it discharges above the I/C. Using a straight metal connector, attach a 90° elbow between the 180° and the box inlet. Clamp.

### **Remotely mounted intercoolers:**

1. Review figures F1 - F4 before starting. Determine where you are going to mount the intercooler. The intercooler has several mounting tabs attached to it, find a place where these can be used, it will be out of the way of the engine, and sits close to the level of the outlet of the ProCharger. Generally, you would like to keep it somewhat close to the engine to minimize the distance the charge air has to flow and the number of bends it has to make. Refer to figure F2 for an example. After you have determined the mounting location, bolt or screw the side tabs to the mounting surface. Included in the kit is a straight piece of strap. At the bottom of the intercooler is another tab. Bend and drill the strap so that it can be bolted to the bottom tab and to another mounting surface.



**FIGURE G1**  
*CROSSOVER TUBE/WATER TEE FITTING*



**FIGURE G2**  
*TYPICAL WATER ROUTING (NOTE: COOLER SEQUENCE WILL VARY BY BOAT)*

2. You should have a long section of 3" tubing. This tubing will be cut to make the intercooler tubes. After you make a cut, clean up the ends with a file or sander and flare. Flare the end by closing down a crescent wrench so that it just fits over the tubing wall. Pull out on the wrench slightly so that about 1/4" of the wall is crimped outward at about a 20° angle. Do this all the way around the tube. When done, fit a rubber connector over the end to make sure it is not flared too much. After the first one, you should get a good idea of how much flare is needed.
3. Measuring out the proper distances, use a series of straight metal tubes, rubber connectors, and rubber elbows, to run between the outlet of the ProCharger and one side of the intercooler, being sure to bend around obstructions.
4. Again, using a series of metal tubes, connectors, and elbows, plumb the intercooler tubing from the other side of the intercooler to the 3" end of the elbow on the carburetor cover. Clamp all connections on the system securely with the appropriately sized hose clamps.
5. Test your intercooler system to insure that it is rigidly mounted (it will be full of water when in operation) and does not interfere with other systems within the compartment.

#### **Air inlet system:**

1. Connect the flame arrestor/ filter to the ProCharger using the supplied hose clamp.
2. Using the supplied 1/2" x 2 ft and 3/8" x 2 ft hose, route the valve cover breather fittings to the inlet elbow fittings, cutting the hose to length as required.

## **G. WATER LINE INSTALLATION**

### **DESCRIPTION AND OPERATION**

The water lines established in this section allow water to be routed to and from the air-to-water intercooler. This is accomplished by routing hose to crossover tube fitting for the feed line, and installing an over board fitting for the discharge line.

1. Reattach the 1" water lines running to the exhaust to the fittings on the thermostat housing.
2. Attach supplied 1/2" hose to small barb fitting on crossover tube. Route hose away from belts and attach to lower fitting on intercooler. It is important that the water feed line for the intercooler be attached at the bottom and the discharge at the top, otherwise the intercooler will not fill up with water and will provide little cooling effect.
3. Intercooler over board fitting can be located in either two locations above the drive unit for cooling (if not using drive shower) or on driver side of hull for water flow verification through intercooler. Drill a hole to match the size of the outer diameter of the supplied overboard. Cover the outside of the fitting with silicone and slide through the hole with the barb fitting on the inside. Tighten down the nut on the fitting to secure the fitting to the hull. Attach remaining 1/2" hose to top fitting on the intercooler route hose to over board fitting and clamp securely at both ends.

# PROCHARGER MARINE APPLICATION GUIDE

LOCATE MOTOR AND DESIRED HP LEVEL TO IDENTIFY RECOMMENDED CONFIGURATION

MerCruiser™ Motor	ProCharger System	Boost Level	Crankshaft HP*	Fuel System Upgrade Required	Carb Rec**	Min Octane	Engine Modifications Required
350 MPI (300/330 hp)	Intercooled, 5 psi (’97-2001)		430	Included in ProCharger system	n/a	91	thru-transom exhaust req’d
350 MPI	Intercooled, 7 psi (’82-2006 only)		440	Fuel System Upgrade Required	n/a	91	thru-transom exhaust req’d
5.7/350 (250/280 hp)	M-1B Intercooled	3.5 psi	385	-	600	89	-
350 Mag	M-1B Intercooled	5 psi	390	-	300	91	thru-transom exhaust req’d
350 Mag	M-1 Intercooled	7 psi	415	-	600	91	thru-transom exhaust req’d
350 Mag	M-1 Intercooled	6 psi	413	-	300	91	thru-transom exhaust req’d
350 Mag	Standard	4 psi	355	-	600	91	exhaust recommended
7.4 (300/330 hp)	M-1 Intercooled	3.5 psi	435	-	600	89	-
7.4	M-1 Intercooled	6 psi	438	-	300	90	-
7.4	M-1 Intercooled	7 psi	435	Electric Feeder Pump Kit	600	91	thru-transom exhaust req’d
7.4	M-1 Intercooled (18.75)	8 psi	435	350 HP Fuel System***	300	91	thru-transom exhaust req’d
7.4 MPI (310/340 hp)	M-1 Intercooled	5 psi	500	Included in ProCharger system	n/a	89	thru-transom exhaust req’d
7.4 MPI	M-1 Intercooled	7 psi	490	Fuel System Upgrade Required	n/a	91	thru-transom exhaust req’d
454 Mag (350/380 hp)	M-1 Intercooled	3.5 psi	500	-	650	89	thru-transom exhaust req’d
454 Mag	M-1 Intercooled	6 psi	498	Electric Feeder Pump Kit	300	91	thru-transom exhaust req’d
454 Mag	M-1 Intercooled	6 psi	570	550 HP Fuel System***	650	91	thru-transom exhaust req’d
454 Mag	M-1 Intercooled (18.75)	7.5 psi	498	Competition Fuel System	300	91	thru-transom exhaust req’d
454 Mag	M-3 Intercooled	8 psi	675	Competition Fuel System	650	91	thru-transom exhaust req’d
454 Mag	Standard	3 psi	300	-	300	91	cdl
454 MPI (385/415 hp)	M-1 Intercooled	3.5 psi	540	Included in ProCharger system	n/a	89	thru-transom exhaust req’d
454 MPI	M-1 Intercooled	6 psi	530	Included in ProCharger system	n/a	91	thru-transom exhaust req’d
454 MPI	M-3 Intercooled	5 psi	630	Included in ProCharger system	n/a	89	thru-transom exhaust req’d
454 MPI	M-3 Intercooled	7 psi	630	Included in ProCharger system	n/a	91	thru-transom exhaust req’d
502 MPI (415/445 hp)	M-1 Intercooled	3.5 psi	570	Included in ProCharger system	n/a	89	thru-transom exhaust req’d
502 MPI	M-1 Intercooled	6 psi	630	Included in ProCharger system	n/a	91	thru-transom exhaust req’d
502 MPI	M-3 Intercooled	5 psi	645	Included in ProCharger system	n/a	89	thru-transom exhaust req’d
502 MPI	M-3 Intercooled	7 psi	690	Included in ProCharger system	n/a	91	thru-transom exhaust req’d
498 HO (425/455 hp)	Intercooled	3 psi	530	Included in ProCharger system	n/a	91	thru-transom exhaust req’d
500 EF (500 hp)	M-1 Intercooled	3.5 psi	660	Included in ProCharger system	n/a	91	thru-transom exhaust req’d
500 EF	M-1 Intercooled	6 psi	640	Included in ProCharger system	n/a	91	thru-transom exhaust req’d
500 EF	M-3 Intercooled	5 psi	785	Included in ProCharger system	n/a	91	thru-transom exhaust req’d
500 EF	M-3 Intercooled	6 psi	800	Fuel System Upgrade Required	n/a	91	thru-transom exhaust req’d
HP 500 (500 hp)	M-1 Intercooled	4.5 psi	710	Competition Fuel System	stock 800	91	-
HP 500	M-1 Intercooled (18.75)	7 psi	790	Competition Fuel System	cdl	91	-
HP 500	M-3 Intercooled	8 psi	820	Competition Fuel System	cdl	91	-
HP 500	Standard	3 psi	300	cdl	stock 300	91	cdl

\* Crankshaft hp with ProCharger system running indicated octane fuel with factory rev limiter (subtract 30 hp for prop hp rating)

\*\* All carbureted applications require Holley double pumper (carburetor prep kit included with system, carburetors sold separately)

\*\*\* Location of fuel tanks/pickups may require Competition Fuel System; consult with A.T.

Note: Ignition upgrade may be required for applications generating more than 600 crankshaft horsepower

Note: Air horns are now supplied with all systems instead of air filters. Air horns are easier to install and provide improved airflow due to their venturi effect.

• Returns of new (unused) equipment must be pre-approved with an ROA number and will have a 10% restocking fee applied. No returns accepted after 90 days

• Supercharger systems are sealed at the factory; systems returned with factory seal intact are subject to only a 5% restocking fee

• Used, damaged, discontinued and special order items are not returnable

• All prices are F.O.B. Lenexa, Kansas. Prices and specifications are subject to change without notice.

## **H. FUEL SYSTEM UPGRADES (SEE APPLICATION GUIDE ON FACING PAGE)**



**Warning:** Ensure that all fuel lines are correctly sized for the supercharged horsepower rating of the engine. Please contact an ATI service technician should you have any questions.

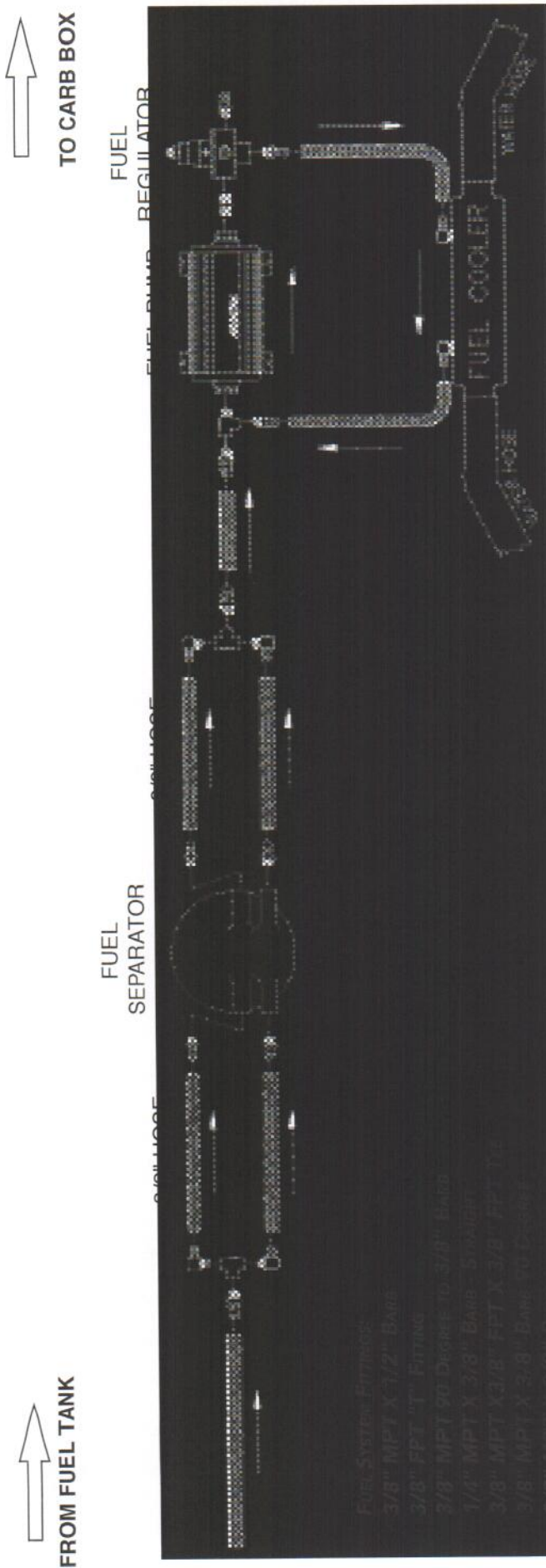
### **H1. MARINE BLOW-THROUGH CARBURETOR MODIFICATION**

1. Remove the choke butterfly from its shaft in the choke horn. Unhook the shaft from the choke linkage and slide out of the carburetor. Remove the three bolts holding the choke linkage assembly to the carburetor. Remove the entire choke linkage assembly.
2. Cut the section of the throttle linkage which hangs down below the mounting surface of the carburetor. Identify the tab which is bent outward on the top part of the throttle linkage. Either cut this tab or bend it back even with the rest of the linkage.
3. Remove the front and rear float bowls. Remove the stock floats and replace with the supplied black nitrophyll floats. The notched float (for use with jet extensions) goes on the back bowl. Before replacing the bowls, change jet sizes and push the supplied jet extensions onto the rear jets.
4. If your carburetor is not a marine carburetor, remove the straight bowl vent tubes with vise-grips or pliers. Install the supplied "J" shaped vent tubes into the vents so that they discharge into the carburetor. Tap the tubes into place lightly with a hammer so that they fit tightly, but avoid excessive denting of the tubes.

### **H2. GEN. V HOLLEY FUEL PUMP CONVERSION (OPTIONAL, SEE FACING PAGE)**

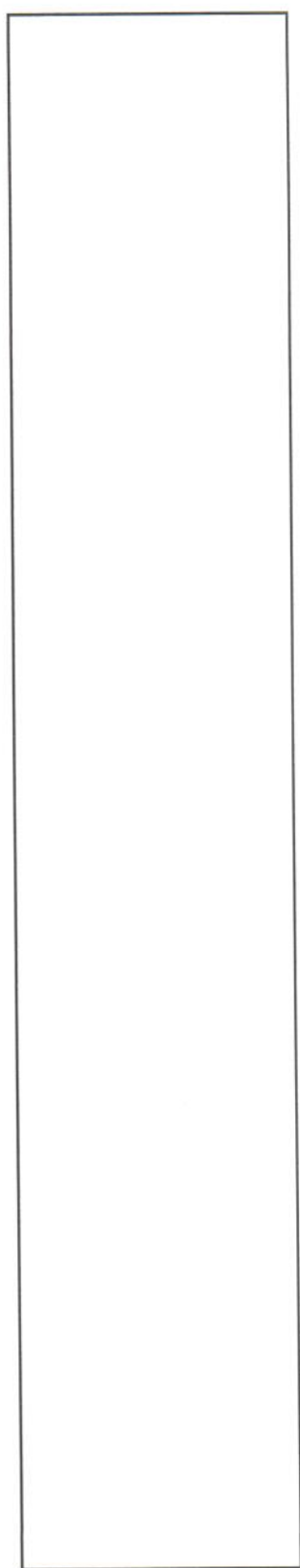
*Note: Holley mechanical fuel pumps are a direct bolt on replacement for the stock pump on Generation IV motors (with the mechanical fuel pump bolted to the engine block). Only Generation V motors (with the mechanical fuel pump bolted to the seawater pump) require the following steps.*

1. Remove the 6 bolts holding the bottom half of the stock fuel pump to the top. Keep the bolts for reassembly. Remove the bottom. This piece will not be reused.
2. Orient the adapter plate with the counterbored bolt holes facing out. Using the original bolts in the counterbored holes, attach the adapter plate to the top part of the fuel pump.
3. If not already done, remove the bottom section of the supplied Holley fuel pump from the top. Align the mounting holes in the Holley fuel pump bottom with the holes in the adapter plate so that the inlet and outlet are in the desired position. Two of the bolts and mounting holes in the fuel pump bottom will not be used.
4. Run the Holley bolts back through the pump bottom. Match the holes in the supplied gasket with the pump bolts and push the gasket down onto the bolts. Thread into the adapter. Tighten all bolts securely.
5. Attach the fuel lines to the pump. Start the engine and check for leaks.



**FIGURE H1**  
**COMPETITION FUEL SYSTEM**

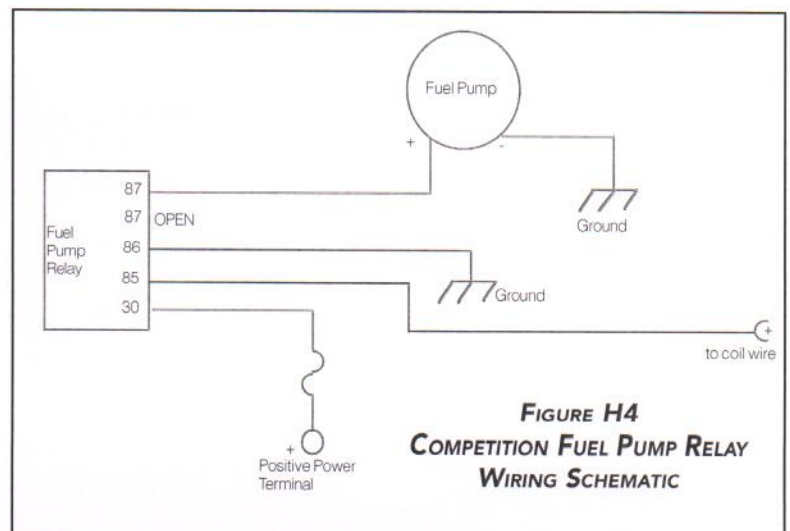
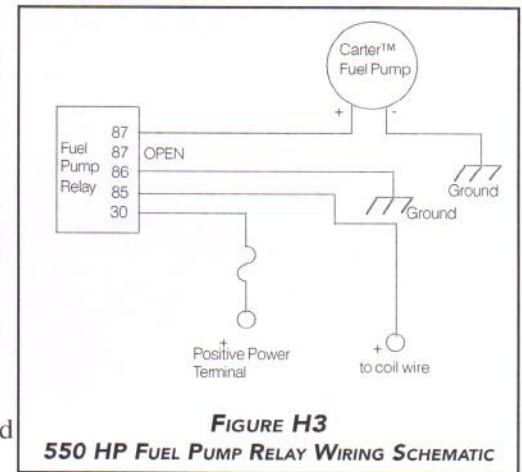
- ⑧ 3/8" MPT X 3/8" BARB 90 DEGREE
- ⑨ 3/8" MPT X 1/8" FPT REDUCER
- ⑩ 3/8" MPT X 3/8" MPT UNION
- ⑪ 10 AN X 3/8" FPT REDUCER



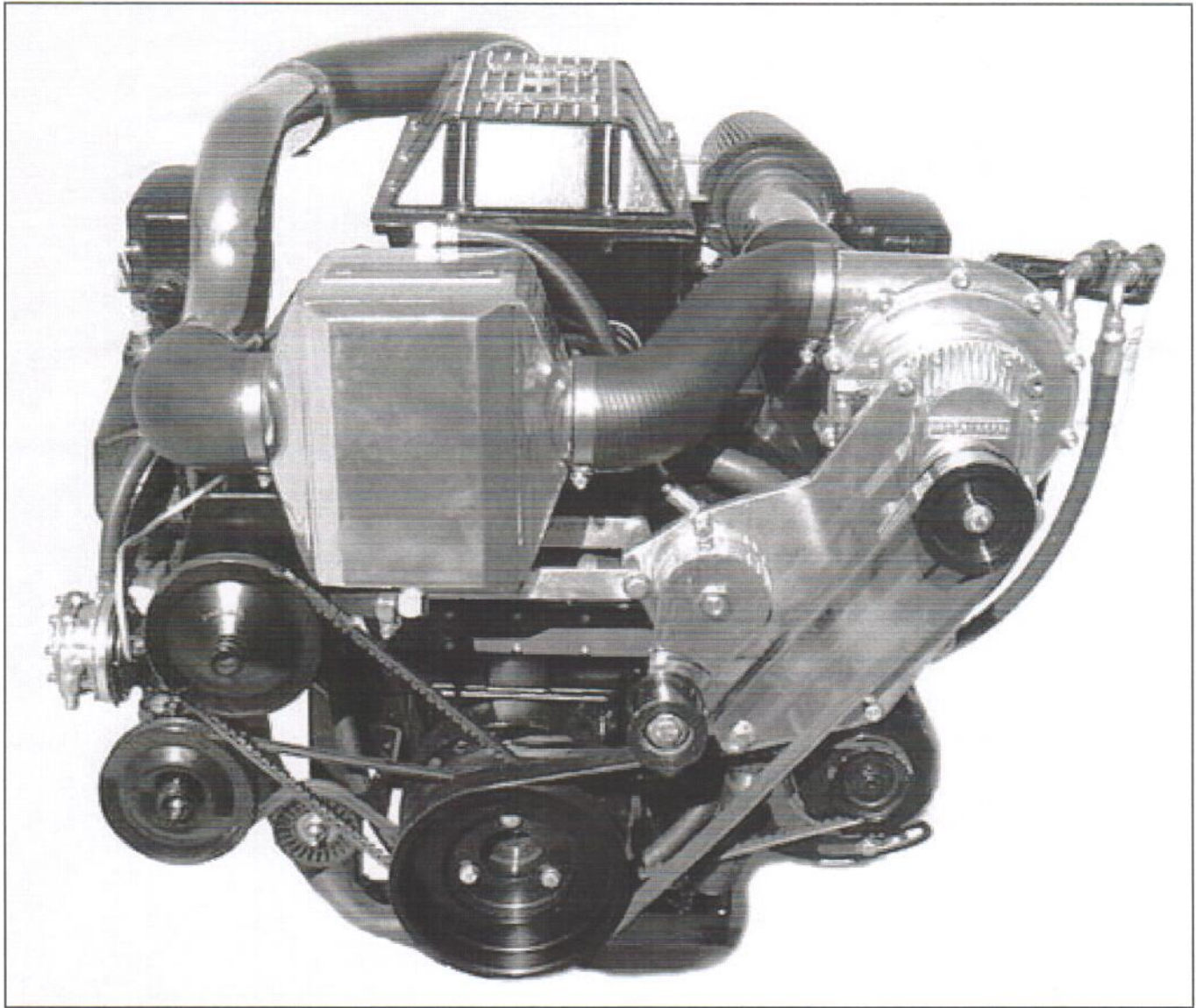
**FIGURE H2**  
**550 HP FUEL SYSTEM**

### H3. COMPETITION ELECTRIC OR 550 HP FUEL SYSTEM INSTALLATION.

1. Refer to figure H1 or H2 as appropriate. Locate the spot where you will mount the electric fuel pump near the water separator. You want to find a section as low as possible with a 2 ft. straight run. The fuel pump needs to be located low so that gravity is constantly feeding the pump.
2. Attach 1/2" barb fittings to the electric fuel pump if not already done. 1/2" is the most common size for fuel lines, so all fittings in the fuel system kit are 1/2" barb. If your supply line is a different size, you will need to get different fittings.
3. Set the pump where you intend to mount it. Using the pump's mounting bracket as a template, mark the holes on the mounting surface. Using a 1/8" bit, drill the two marked holes. Using two of the #12 screws, mount the fuel pump bracket.
5. Remove the old outlet fitting from the water separator. Install a 1/4" NPT-1/2" barb fitting. Run a section of fuel hose between the water separator and the fuel pump inlet. Attach another section of fuel line to the outlet of the fuel pump. Securely hose clamp the lines.
6. Determine where the fuel pressure regulator will be mounted. Using its bracket as a template, mark the mounting holes. Drill out the mounting holes. Install the remaining barb fittings in the inlet and one outlet of the regulator. Plug off the unused outlet port(s).
7. Run the fuel line from the pump to the regulator. The line from the fuel pump goes to the port marked "inlet". The outlet goes up to the separator. Using two #12 screws, attach the regulator. Clamp down the hose sections with the remaining hose clamps.
8. Find a place nearby the fuel pump to mount the fuel pump relay. You may either use the remaining screw or an existing fastener.
9. Refer to illustration H3 or H4 depending on your system. Using an electrical "T" connect the yellow wire from the relay (#87) to the positive (+) lead on the fuel pump.
10. Connect the black wire from the relay (#86) to the ground (-) lead on the pump.
11. Run the red wire from the relay (#30) to the power terminal on the alternator or on the battery using the supplied inline fuse and ring connector.
12. Attach the green wire from the relay (#85) to a switched power source (one that is only powered with the key in the "on" position such as the coil).
13. Run the black ground wire(s) from the fuel pump to a ground on the engine, etc.
14. Turn the key to the on position. You should be able to hear the pump activate. If unsure, you can feel the pump vibrate as it activates. If the electric pump does not come on, double check all connections, especially the ground connections.



\* Optional, see fuel system upgrade chart on preceding page.



**FIGURE I1.**  
**COMPLETED INSTALLATION**





## **I. INSTALLATION REVIEW AND SAFETY CHECK**

1. Carefully review the entire installation (figure I1). Check oil and fuel lines near moving parts and the exhaust system to ensure that these lines are safe, secure and not twisted or kinked. All wires and hoses should be firmly secured with clamps or wire ties. Also, ensure that the air filter or inlet screen is installed.
2. Check all fluid levels. Your tank should be filled with 91 octane or higher fuel before any hard running.
3. Start engine and idle for a few minutes. You should be running stock Mercruiser timing. Check and adjust if necessary. It is better to err on the side of less timing and no detonation!
4. Shut off engine and check for fluid leakage, signs of rubbing parts, and other potential problems.
5. Your motor should display a significant increase in performance when you are hard into the throttle, with no signs of detonation. If this is not so, review your installation, then contact your dealer or ATI for assistance.
6. For best performance and reliability, **always use premium grade fuel (91 octane or higher)** and listen for signs of detonation. Back off throttle should detonation occur. With a properly installed ProCharger and appropriate timing, detonation should not be an issue.
7. Never race your engine (and ProCharger) when your engine is cold. Allow the water temperature to climb into operating range before revving above 2,500 rpm.
8. Be sure you have purchased and properly installed a fuel pressure gauge and/or fuel/air ratio meter to monitor fuel delivery. Installation of a boost pressure gauge is also recommended. **Important: Your fuel pressure must increase pound for pound with your boost (Example: if your idle fuel pressure is 8 psi and you make 5 psi of boost, your boosted fuel pressure should be 13 psi.). If your fuel pressure does not increase with relation to boost, do not operate motor into boosted range, as engine damage may occur.** Verify all fuel system plumbing and routing of the boost reference line routed between the carb box and the fuel pump.
9. It is very important that all fuel lines are sized according to the supercharged horsepower rating of the engine. This includes the anti-siphon valve, fuel filters, etc. . Please contact an ATI service technician should you have any questions.
10. Please review the maintenance and warranty sections within this owner's manual

# TUNING

## Fuel Pressure and Jetting

On a carbureted motor, adequate fuel pressure and correct jetting are the most important factors in maintaining the correct fuel-air ratio. When supercharging a carbureted motor, extra fuel beyond that supplied by the stock fuel pump and carburetor/jets is required, due to the extra oxygen in the cylinder. This extra fuel is provided by upgrading your fuel systems and increasing the stock jetting on a Holley double pumper carburetor (see fuel systems recommendation chart on back of price list and in section H of this manual. Variations in fuel pressure gauges can cause improper fuel pressure readings on the gauge; therefore, what is important is the observed **increase** in fuel pressure (not the overall fuel pressure, but the amount of additional pressure added to the stock pressure at idle). After the system is installed, fuel pressure at idle should be checked. Whatever that reading is, under boost you should see an increase of 1 psi of fuel pressure for every 1 psi of boost pressure. It is extremely important to check the fuel pressure as the motor may run fine, **but due to insufficient pressure may be dangerously lean and exposed to serious engine damage.** Carburetor jetting must also be correct. Never run a ProCharged motor with stock jets! ProCharged motors will always require jets larger than stock. Please contact your dealer or an ATI technician regarding jetting recommendations.

## Timing

All motors may require subtly different timing for best tuning. However, as most motors are close to the same, we can give general guidelines. Most medium sized V Hulls, twin engine applications, and generally boats with 1.50 gear ratios or more (lower) that are able to plane with relative ease in a tall propped, high speed setup, will generally not need as much initial timing. Dyno results have shown that most moderate compression GM BB's, such as Mercruiser types will not show significant variances in peak HP if total timing is between 29-32°. However, in the previously mentioned boat types which exhibit good planing & driveability characteristics, backing the timing down from the 32° Merc. Stock setting can provide some additional margin for error in the event the boat is operated with insufficient octane fuel and/or other abuses. Large single engine boats, high speed tunnel cats, and other high performance and/or 1.36 geared boats may benefit from the more advanced Merc. total 32° specification, since this will essentially increase on-plane torque due to non-aggressive low RPM tuning. Although this aggressive timing will not allow as great a margin of error at WOT, this should not pose a problem, due to the fact that these high performance applications are only capable of short bursts of full throttle operation due to water speed and general safety conditions. Obviously, the manner in which the desired timing is set will ultimately influence the final jetting.

## Plugs

As to reading the plugs, the following information should help identify what to look for: What we want to focus on is the threads. The threads are directly connected to the cylinder, and so when the plug is removed, essentially part of the combustion chamber is removed. On almost all cases the appearance of the top of the plug threads is also what the chamber and pistons look like. We want the threads and the chamber to be black and have soot deposits. This indicates a rich supercharged condition and therefore would mean cooler exhaust temperatures. The negative ground should be clean and show no signs of blue discoloration. The electrode should be clean and white; this indicates good combustion. The following are signs of problems: If the negative ground is discolored, it indicates high temperatures. If the electrode is fuel soaked or black this indicates a misfire or fouled plug condition. If any of the 1st thread is not completely black, there is not enough fuel in the cylinder. Even if only a small part of the thread's circumference is clean, this condition may produce excellent power, but will probably produce excessive cylinder temperatures.

## **CHECKING YOUR EGT'S AND/OR READING YOUR PLUGS IS EXTREMELY IMPORTANT!**

Many activities that are good for you are usually not too enjoyable. Fortunately, when it comes to your marine engine, the simple process of monitoring your exhaust gas temperatures (EGT's) or reading your plugs can save thousands of dollars of unnecessary engine repairs and provide many enjoyable hours of trouble free service.

Monitoring EGT's requires the installation of EGT probes and gauges. If you are not familiar with this process, contact your dealer or an ATI service technician. Reading your plugs is a relatively simple alternative to monitoring EGT's, but is not as precise.

As for reading plugs, we must first start by saying that **when** a plug is read is as important as **what** is observed. If a spark plug is removed & read at the wrong time, not only will a misdiagnosis occur, but in many cases the tuner may actually mistakenly tune the engine in the wrong direction and unintentionally create a lean engine-damaging condition. Therefore, the only real way to read plugs is to remove the spark plugs immediately following a wide open throttle, full power condition. This is done by accelerating the boat at wide open throttle to full operating range for a few seconds, or until it is clear that rapid acceleration has ceased ( in most marine engines a good plug reading can be taken from 4500 to 5500 rpm) and then immediately shutting off engine and coasting to a stop. Although many spark plugs may only require less than 60 seconds each to be read & completely reinstalled, this previously described simple process provides a tremendous opportunity to literally take a snapshot of the combustion process and what is happening inside the engine.

If a hundred engine builders were asked to estimate what it would require to properly tune your engine there may be a hundred different answers since no two engines are exactly alike. It is called the cumulative tolerances theorem, a half a percent difference in total valve lift, a slight variance in piston ring gap, a small amount of unremoved casting flashing in a cooling passageway, and hundreds of other minute differences can lead to identical engines requiring some differences in fuel pressure to produce proper and uniform combustion. To properly read a spark plug we must first have the correct spark plug. Most Champion, AC & other GM spark plugs are easy to read; however, many Ford Motorcraft are black in color & therefore difficult to read. It is suggested for best results that a brand new set of spark plugs be installed before any attempts to gather information. Let us remind you the following tuning tips are based on unleaded pump gas operations in the stock compression ratio range. Since today's pump fuels register significantly lower octane ratings, and therefore are significantly more susceptible to engine knock or ping, than yesterdays high octane fuels, it is important that some additional fuel be placed in the cylinder - not intended to be burned, but just to act as a cooling medium. This simply means that a richer than "ideal" air fuel ratio is now highly desired for maximum performance on todays pump gas engines. After the system is installed, fuel pressure at idle should be checked. Whatever that reading is, fuel pressure under boost should rise by **at least** 1 psi for every psi of boost pressure. For example, if your fuel pressure is 7 psi at idle and you are running 7 psi of boost at max rpm, then fuel pressure should be at least 14 psi at the max rpm. This increase in fuel pressure is accomplished by boost-referencing your fuel system as discussed in the fuel system installation instructions. It is extremely important to check the fuel pressure as the motor may run seemingly fine, but due to insufficient pressure is running dangerously lean. Carburetor jetting must also be correct. Never run a ProCharged motor with stock jets! ProCharged motors will always require larger than stock jets. Please contact an ATI technician regarding jetting recommendations. You will still need to read your plugs to finalize the jetting, but ATI Technical Service can at least give you a good starting point. Remember that leaning the motor will increase HP but can create an extremely dangerous lean condition - which can result in severe engine damage.

# OPERATION AND MAINTENANCE

- **COLD STARTING**

Never race your engine (and ProCharger) when your engine is cold. Allow the water temperature to climb into operating range before revving above 2,500 rpm.

- **FUEL QUALITY**

For best performance and reliability, **always use at least 89 octane fuel (91 octane with 7 psi)**. Always listen for signs of detonation after refueling, and after replacement or modification of any fuel system components. Back off throttle should detonation occur. With a properly installed ProCharger intercooled supercharger system, detonation should not be an issue

- **OIL AND FILTER MAINTENANCE**

M1 only: Always change your oil and filter every 25-30 hours. Delaying your oil change beyond the recommended interval risks the health of both your high performance engine and ProCharger. M-1SC and M-3SC models, see SC applications page for SC oil change intervals.

- **IGNITION SYSTEM MAINTENANCE**

If your spark plugs are more than two years old or have more than 100 hours use, you should change your plugs before operating your boat under load. Additionally, spark plug wires should be changed every 200 hours of use, or whenever resistance exceeds factory specifications.

- **AIR INLET**

**Your motor and ProCharger should never be run without an air inlet screen!**

- **BELT TENSIONING AND REPLACEMENT**

The belt which turns your ProCharger will stretch after initial run-in, and may need retightening after the first few hours, if not sooner. After possibly one more tightening of the belt with the tensioner, further stretching should not occur. Tighten the belt sufficiently to avoid slippage, but do not overtighten, as this could cause damage to the ProCharger's precision bearings. Should you throw a belt and find that it needs constant retightening, the belt is damaged and should be replaced. 8-rib belts can be bought from ATI or your local parts store. Gates Micro-V belts are recommended; these belts are available at CarQuest™, NAPA™ and other auto parts stores. Your nearest CarQuest store can be found by dialing 800-492-7278, the nearest NAPA store at 800-538-6272.

- **IMPELLER SPEED**

Maximum impeller speed should not exceed the redline stated for each model in the table below. Maximum impeller speed = crankshaft pulley diameter (D1) divided by supercharger pulley diameter (D2), multiplied by the step-up ratio stated in the table, multiplied by engine rpm at redline.

$$\text{Impeller RPM} = (D1/D2) \times (3.05, 4.10 \text{ or } 4.44) \times \text{engine RPM}$$

Model:	M1B	M1	M1SC	M2	M3SC	M3	M4
RPM (MAX):	54,000	50,000	57,000	59,000	50,000	53,000	50,000
Step-Up Ratio:	3.05:1	3.05:1	4.10:1	4.44:1	4.10:1	4.44:1	4.44:1

If you require technical support please contact us at (913) 338-3086 9:00-5:00 CST, Monday - Friday, or contact technical services via email at [techserv@procharger.com](mailto:techserv@procharger.com)

# SC APPLICATIONS

- **WARNING:**



**ALL SC SUPERCHARGERS CONTAIN NO OIL FROM THE FACTORY. YOU MUST ADD THE SUPPLIED PROCHARGER OIL PRIOR TO USE.**

Use only ATI supplied oil in your SC ProCharger. The ATI oil has been specially formulated for the bearings in the ProCharger and use of oil other than that supplied by ATI will void your warranty.

- **OIL CHANGE INTERVALS**

The first oil change should be performed at 15 hours and at 100 hour intervals thereafter. Clean drain plug after every oil change. Drain oil by removing the magnetic drain plug. Clean off the magnetic drain plug before reinstalling. *See figure below, left*

- **OIL LEVEL**

The oil level must be checked periodically (when cold) to ensure the proper oil level in the ProCharger. The dipstick can be loosened using a flat blade screwdriver or a coin. When installed, the oil level should be between the min and max levels (See fig. below). If the oil level falls below min, fill the ProCharger, through the dipstick hole, until the proper oil level is reached. **Warning: Filling the ProCharger higher than the "max" level on the dipstick will lead to bearing and/or seal damage.** The SC ProChargers are sealed units and normally will not require the addition of oil between service intervals. If excessive consumption is noted, the unit should be sent to ATI for inspection/repair. Disassembly of the supercharger will void your warranty.

- **GENERAL**

When removing the dipstick, be sure to retain the nylon washer. A spare washer is provided with each box of SC oil (a box is included with each system). Do not remove or replace either the nylon washer on the dipstick, or the rubber o-ring on the drain plug with anything other than ATI supplied replacements. **Evidence of either case may void factory warranty.** A discoloration of the oil and residue on the drain plug will be noticed during initial oil changes. This is no cause for concern and will eventually diminish. The serial tag on your SC ProCharger must be pointing upwards for proper orientation. Installing the supercharger in another orientation will result in inadequate oiling and supercharger failure. If you have any questions about the maintenance of your SC ProCharger they should be directed to an ATI service technician or dealer.



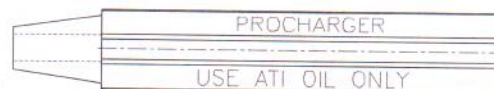
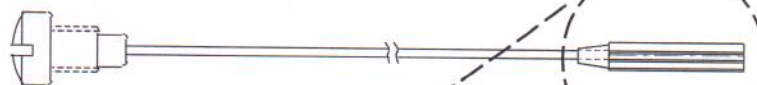
SEALED PLUG  
(SOCKET HEAD)

MAGNETIC  
DRAIN PLUG  
(HEX HEAD)



SEALED PLUG  
(SOCKET HEAD)

DIPSTICK  
(FLAT HEAD)



## **THE PROCHARGER® AND PROCHARGER INSTALLATION SYSTEM LIMITED WARRANTY**

Accessible Technologies, Inc. ("ATI") is proud to offer a twelve-month limited warranty on its ProCharger products. ATI's warranty obligations are limited to the terms set below:

ATI warrants the ProCharger and ProCharger installation system (together "product") against defects in materials and workmanship for a period of TWELVE (12) months from the date of original purchase from your local dealer, or date of shipment from the factory if purchased directly from ATI. If the product is used in its intended manner, ATI will repair or replace any component found to be defective at no charge to the customer. **SHOULD THE CONSUMER ELECT TO USE A DRIVEN PULLEY OTHER THAN THE ORIGINAL PULLEY SHIPPED WITH THE SYSTEM, THIS TWELVE-MONTH LIMITED WARRANTY IS VOID.** This warranty coverage is extended only to the original consumer purchaser, and excludes hoses, sleeves and electronic support components manufactured by other companies.

To obtain service under this warranty you must do the following during the warranty period:

1. Phone ATI (913-338-3086) and provide us with the following information:
  - ProCharger serial number
  - vehicle year, make, model, engine modifications and other modifications
  - description of perceived problem
2. If no solution to your problem can be found after the above phone conversation, you will be assigned a warranty claim number. You must then properly ship your product, at your expense, to the ATI factory. The product should be carefully packaged in a rugged box so that none of the components being shipped could strike each other or the side of the box during shipping. The box should be strong enough to safely contain the weight of the components being shipped.
3. Include the following information inside the box with your product:
  - copy of your original invoice or receipt
  - name, address and daytime telephone number
  - warranty claim number
  - vehicle year, make, model, engine modifications and other modifications
  - description of perceived problem
4. Clearly mark the warranty claim number on the top and one side of the box in characters no less than 2" tall. Ship the properly packaged product, prepaid and insured for the retail value of the component(s) being returned, to the following address:  
Accessible Technologies, 14801 West 114th Terrace, Lenexa, Kansas 66215.

ATI agrees to honor a warranty claim at its sole discretion and only after inspection by engineers at the ATI factory. No warranty will be honored if any product subassembly is found to have been improperly installed, tampered with, mishandled or misused in any way. **DISASSEMBLY OF THE PROCHARGER OR REMOVAL OF THE PROCHARGER SERIAL PLATE VOIDS ALL WARRANTIES.** Claims for freight damages should be directed to the freight company.

If ATI's limited warranty applies, your product will be repaired or replaced at ATI's option and shipped back to you, freight prepaid, via UPS ground service. If the limited warranty does not apply, we will advise you of the specific reason for denial, and advise you of repair expense and timing. After advising you of this information we will, at your option, either proceed with repairs or return your product to you in the state in which it was received. In either case the product will be shipped to you COD, insured at replacement value. This means that you would pay the return shipping and insurance charges if ATI's limited warranty does not apply to your product.

**THE WARRANTY AND REMEDIES SET FORTH ABOVE ARE EXCLUSIVE AND IN LIEU OF ALL OTHERS, WHETHER ORAL OR WRITTEN, EXPRESS OR IMPLIED. THE DURATION OF ANY AND ALL WARRANTIES ON THE PRODUCTS DISCUSSED ARE LIMITED TO TWELVE MONTHS. ATI IS NOT RESPONSIBLE IN ANY EVENT FOR DIRECT, SPECIAL, INCIDENTAL OR CONSEQUENTIAL DAMAGES.** No ATI dealer, agent, or employee is authorized to make any modification, extension, or addition to this warranty.

# **THE PROCHARGER SC**

## **EXTENDED COVERAGE PROGRAM**

### **DESCRIPTION**

- The ProCharger Extended Coverage Program extends the warranty coverage for your M-1SC or M-3SC ProCharger an additional TWENTY-FOUR (24) months, for a total of thirty-six months. This extended coverage applies to parts and labor for the ProCharger centrifugal supercharger unit only, and does not include other system components.
- Under the extended coverage program, ATI will repair or replace any component within the ProCharger which is found to be defective.
- Service under the extended coverage program is obtained through the same process as described in The ProCharger Twelve Month Limited Warranty.

### **QUALIFICATION**

- Only the original consumer purchaser of the ProCharger is eligible, so long as this purchaser qualifies under the terms described below.
- Completion of the Extended Coverage Registration Form is required, along with a \$49 registration fee. In return for the \$49 registration fee, your system record will be updated to reflect the extended warranty and you will receive (6) additional bottles of ATI SC oil. This form must be completed in its entirety, and must be submitted along with payment within 30 days from the date of original purchase from your local dealer, or date of shipment from the factory if purchased directly from ATI.
- **PARTICIPANTS MUST HAVE ORDERED THE PROCHARGER WITH AN 8 RIB DRIVE SYSTEM WITH THE 5 PSI (OR LESS) PULLEY,** and must agree to maintain this original pulley, and not remove this pulley or disassemble or modify the ProCharger unit in any manner. With respect to the ProCharger itself, all terms and conditions within the ProCharger Twelve-Month Limited Warranty apply. Tampering with the driven pulley and any other modification of the ProCharger unit will disqualify an owner from participating in the Extended Coverage Program. Acts resulting in disqualification include but are not limited to the following:
  - Removal or attempted removal of the ProCharger driven pulley
  - Removal or attempted removal of the ProCharger serial plate
  - Removal or attempted removal of the compressor housing or transmission case
- **PARTICIPANTS MUST AGREE TO PROPERLY MAINTAIN THE PROCHARGER, AND PROVIDE PROOF OF COMPLIANCE WITH THE FOLLOWING REQUIRED MAINTENANCE:**
  - Only ATI supplied oil must be used in the ProCharger.
  - ProCharger oil level must always remain within the specified limits.
  - ProCharger oil change every 100 hours using the ATI supplied oil. (After initial oil change at 15 hours)
  - See special notes on SC applications page.





# PROCHARGER® SC EXTENDED COVERAGE PROGRAM REGISTRATION FORM

(MUST BE RETURNED WITHIN 30 DAYS OF PURCHASE WITH \$49 CHECK)

Name: \_\_\_\_\_

Date of Purchase: \_\_\_\_\_

Address: \_\_\_\_\_

Purchased From: \_\_\_\_\_

City: \_\_\_\_\_

ProCharger Serial #: \_\_\_\_\_

State: \_\_\_\_\_ Zip: \_\_\_\_\_

Boat Year: \_\_\_\_\_

Daytime Phone: \_\_\_\_\_

Boat Make: \_\_\_\_\_

Evening Phone: \_\_\_\_\_

Boat Model: \_\_\_\_\_

Which information sources most influenced your decision to purchase a ProCharger system? Please rank in order of importance (1 = most important, 2 = second most important, etc.).

- Magazine advertising
- Dealer recommendation
- ProCharger Brochures
- Witnessed performance on a car
- Test drive
- Magazine editorials
- Friends
- Conversations with ATI technicians
- Web Site (please specify) \_\_\_\_\_
- Other (please specify) \_\_\_\_\_

What magazines do you read?

- Boating
- Family & Performance Boating
- Hot Boat
- Power & MotorYacht
- PowerBoat
- Sport Truck
- Street Truck
- Trailer Boats
- Truckin'
- Truck Trends

What issues most influenced your decision to purchase a ProCharger system? Please rank the following issues in order of importance.

- Reliability
- Standard warranty
- Extended coverage warranty
- Performance
- Quiet operation
- Removability (ability to return car to stock)
- Cost
- Ease of installation

(Optional)  
Age  18 - 24  25 - 34  35 - 44  
 45 - 54  55 and up

(Optional)  
Income  \$15,000 - \$29,000  \$30,000 - \$44,000  
 \$45,000 - \$69,000  \$70,000 - \$99,000  
 \$100,000 and up

Who installed your ProCharger system?  Dealer  Self  Other

Have you owned a forced induction system previously?  Yes  No

Supercharger: Brand(s) \_\_\_\_\_ Vehicle(s) \_\_\_\_\_

Turbocharger: Brand(s) \_\_\_\_\_ Vehicle(s) \_\_\_\_\_

I have read and understand the terms and qualifications for the ProCharger Extended Coverage Program. I have not modified my ProCharger in any way and will not during my participation in the extended coverage program. I have read and answered all questions on this form. I have also enclosed my check for \$49, payable to ATI, for enrolling my ProCharger (serial # indicated above) in the extended coverage program for an additional 24 months beyond the standard limited warranty period of 12 months.

Signature: \_\_\_\_\_ Date: \_\_\_\_\_

Please mail completed registration form to ATI at: 14801 West 114th Terrace, Lenexa, KS 66215.  
If you have any questions, please contact us at (913) 338-3086 9:00-5:00 CST, Monday - Friday  
Or, contact technical services via email at [techserv@procharger.com](mailto:techserv@procharger.com)

cut along dotted line

cut along dotted line

